



APE POWER UNIT OWNER'S MANUAL

DEEP FOUNDATION SOLUTIONS



800-248-8498

WWW.AMERICANPILEDIVING.COM

MODEL 800 POWER UNIT

Copyright © 2020 American Piledriving Equipment Inc. All Rights Reserved

Copyright © 2020 American Piledriving Equipment Inc.

*All rights reserved, No part of this publication may be reproduced, distributed, or transmitted in any form of by any means, including photocopying, recording, or other electronic or mechanical methods, without prior written permission of the publisher. For permission requests, write to the publisher, addressed **“Attention: American Piledriving Equipment Manual Division”** at the address below.*

AMERICAN PILEDIVING EQUIPMENT, INC.

7032 S. 196th Street

Kent, Washington 98032

Office: 253-872-0141

Toll Free: 800-248-8498

Fax: 253-872-8710

APE_Manuals@americanpiledriving.com



800-248-8498

WWW.AMERICANPIEDIVING.COM

MODEL 800 POWER UNIT

Copyright © 2020 American Piledriving Equipment Inc. All Rights Reserved

Quick Reference Guide

This Quick Reference Guide will assist you in finding the information you're looking for.

GENERAL INFORMATION

MAINTENANCE

TROUBLE SHOOTING

REPLACEMENT PARTS

REFERENCE / NOTES

A Table of Contents is included after the Foreword.

Description:

MODEL 800 POWER UNIT



WARRANTY INFORMATION

American Piledriving Equipment, Inc. (APE) warrants new products sold by it to be free from defects in material or workmanship for a period of one (1) year after the date of delivery to the first user and subject to the following conditions:

- APE's obligation and liability under this WARRANTY is expressly limited to repairing or replacing, at APE's option, any parts which appear to APE upon inspection to have been defective in material or workmanship. Such parts shall be provided at no cost to the user, at the business establishment of APE or the authorized APE distributor of the product during regular working hours.
- This WARRANTY shall not apply to component parts or accessories of products not manufactured by APE, and which carry the warranty of the manufacturer thereof, or to normal maintenance (such as engine tune-up) or normal maintenance parts (such as filters).
- Replacement or repair parts installed in the product covered by this WARRANTY are warranted only for the remainder of the warranty as if such parts were original components of said product.
- APE makes no other warranty, expressed or implied, and makes no warranty of merchantability or fitness for any particular purpose.
- APE's obligations under this WARRANTY shall not include any transportation charges, costs of installation, duty, taxes or any other charges whatsoever, or any liability for direct, indirect, incidental or consequential damage or delay.
- If requested by APE, products or parts for which a warranty claim is made are to be returned, transportation prepaid, to APE.

OIL MUST MEET ISO CLEANLINESS CODE 17/15/11.
OIL THAT DOES NOT MEET CLEANLINESS CODE
WILL **VOID** THE WARRANTY

ANY IMPROPER USE, INCLUDING OPERATION
AFTER DISCOVERY OF DEFECTIVE OR WORN
PARTS, OPERATION BEYOND RATED CAPACITY,
SUBSTITUTION OF ANY PARTS WHATSOEVER,
USE OF PARTS NOT APPROVED BY APE OR ANY
ALTERATION OR REPAIR BY OTHERS IN SUCH A
MANNER AS, IN APE'S JUDGMENT, AFFECTS THE
PRODUCT MATERIALLY AND ADVERSELY, SHALL
VOID THIS WARRANTY.

ANY TYPE OF WELDING ON APE'S EQUIPMENT
WILL **VOID** THE WARRANTY UNLESS AUTHORIZED
IN WRITING BY APE

NO EMPLOYEE IS AUTHORIZED TO CHANGE
THIS WARRANTY IN ANY WAY OR GRANT ANY
OTHER WARRANTY UNLESS SUCH CHANGE IS
MADE IN WRITING AND SIGNED BY AN OFFICER
OF APE, INC.

FOREWORD

This manual covers **APE Hydraulic Power Unit** safety, operation instructions, lubrication and maintenance information. This manual should be stored in or near the engine area in a literature holder or literature storage area.

The data provided in this manual gives the necessary information to operate and maintain APE equipment. The listed procedures are to be performed by qualified personnel who have an understanding of the equipment and who follow all safety precautions.

Some photographs or illustrations in this manual show details or attachments that may be different from your equipment. Continuing improvement and advancement of product design may have caused changes to your equipment which are not included in this manual. Whenever a question arises regarding your equipment, or this manual, please consult with your APE dealer for the latest available information.

Using this manual:

- Refer to the Table of Contents for the page location of applicable sections.
- All weights and measurements are in English and Metric units.
- Please visit www.americanpiledriving.com for product data sheets and manuals and latest available information.

DISCLAIMER:

This unit was tested and flushed before leaving our facility. In order to help provide years of trouble-free usage, please review the following documentation and make sure to clean and flush the quick disconnect fitting on any equipment before connecting it to the power unit.

Refer to schematic diagrams and the BOM (Bill of Materials) for component part specifications and recommended spare parts.

When calling APE, always have the equipment serial number on hand in order to obtain quicker service.

IDENTIFICATION TAG



Serial No. can be found here.

TABLE OF CONTENTS

WARRANTY INFORMATION	4
TABLE OF CONTENTS	6
SPECIFICATIONS.....	7
GENERAL SAFETY PRECAUTIONS	8
GENERAL HAZARD INFORMATION	12
BURN PREVENTION	13
CRUSHING PREVENTION AND CUTTING PREVENTION	14
BEFORE STARTING ENGINE.....	14
ENGINE STOPPING.....	14
ELECTRICAL SYSTEM.....	15
EQUIPMENT OVERVIEW.....	16
CONNECTING THE HYDRAULICS.....	19
START / WARM UP PROCEDURE	20
CONTROL PANEL GAUGES.....	21
CONTROL PANEL OVERVIEW	22
WIRELESS PENDANT	27
CONTROL PANEL DISPLAY	28
MAINTENANCE CHART.....	32
ENGINE OIL	33
ENGINE OIL FILTER	33
HYDRAULIC OIL.....	33
AIR CLEANER REPLACEMENT.....	33
RETURN FILTER ELEMENTS	33
TROUBLESHOOTING	35
UNDERSTANDING THE HYDRAULIC SYSTEM	35
HYDRAULIC SCHEMATIC.....	36
ELECTRICAL SCHEMATIC	38
POWER DISTRIBUTION MODULE ELECTRICAL SCHEMATIC	40
SETTING UP THE PROGRAM	41
UPDATING THE DISPLAY.....	42
UPDATING THE PANEL.....	43
REPLACEMENT PARTS	44
DOUBLE KL3 BYPASS MANIFOLD ASSEMBLY	45
32MM DRIVE MANIFOLD ASSEMBLY	46
COOLER PACKAGE ARRANGEMENT	49



SPECIFICATIONS

DIMENSIONS

Overall Length	186 in	(472 cm)
Overall Width	96 in	(244 cm)
Overall Height	90 in	(229 cm)
Weight	22,750 lbs	(10,319 kg)
Fuel Capacity	178 gal	(674 L)

ENGINE

Type	Caterpillar C18 Tier IV Stage V Dual Certified	
Horse Power	800 hp	(597 kW)
Displacement	1,104 in ³	(18,091 cc)
Compression Ratio	16.1:1	
Engine Speed	1,800 rpm	
Engine Oil	Caterpillar Diesel Engine Oil 10W30 or 15W40	
	42 qt (US)	(40 L)



HYDRAULICS

Drive Pressure	0 - 4,500 psi	(310 bar)
Drive Flow	241 GPM	(912 LPM)
Clamp Pressure	0 - 4,800 psi	(331 bar)
Clamp Flow	10 gpm	(38 LPM)
Pump Drive Oil	Schaefer 268 SAE 140	
	1.5 gal	(5.7 L)
Hydraulic Oil	Envirologic 146	
Hydraulic Capacity	660 gal	(2,498 L)

SAFETY SECTION

General Safety Precautions

GENERAL INFORMATION



DANGER

DANGER indicates a hazardous situation which, if not avoided, will result in death or serious injury.



WARNING

WARNING indicates a hazardous situation which, if not avoided, could result in death or serious injury.



CAUTION

CAUTION indicates a hazardous situation where injury could occur but is unlikely to be serious or lead to death.

NOTICE

NOTICE indicates information that may help or guide you in the operation or service of the equipment.

DISCLAIMER:

This unit was tested and flushed before leaving our facility. In order to help provide years of trouble free usage, please review the following documentation and make sure to clean and flush the field piping before connecting it to the power unit.

Refer to schematic diagrams and the BOM (Bill of Materials) for component part specifications and recommended spare parts.

When calling APE (American Piledriving Equipment), always inform them of the supplied serial # in order to obtain quicker service

NOTICE

READ THIS MANUAL THOROUGHLY BEFORE OPERATING AND / OR WORKING ON THE EQUIPMENT

1. Read and follow any safety instructions in the CATERPILLAR ENGINE OPERATOR'S MANUAL.
2. Only well-trained and experienced personnel should attempt to operate or maintain this equipment.
3. NEVER adjust, lubricate and/or repair the unit when it is in operation or lifted above ground level.
4. NEVER remove, paint over and/or cover warning or safety labels. If labels become damaged or unreadable, replace immediately.
5. All personnel should wear approved safety clothing including HARD HATS, SAFETY SHOES, SAFETY GLASSES and HEARING PROTECTION when near this equipment.
6. Do **NOT** stand any closer to this equipment than necessary when it is in operation. Parts may loosen and fall. **NEVER** stand under operating or elevated equipment.
7. When maintaining and/or repairing the equipment, **NEVER** substitute parts not supplied or approved in writing by APE.

NOTICE

Do NOT weld or flame cut on this equipment.

8. NEVER use or store flammable liquids on or near the engine.
9. Insure that all lifting equipment, including cranes, wire rope, slings, hooks, shackles, etc., are properly sized for the worst caseloads anticipated during operations.
10. If there are any questions about the weights, specifications and/or performance of the unit, contact APE before handling and/or operating the equipment.
11. Check wire rope clips for tightness and wire ropes for wear daily.
12. Insure that ground vibrations will not damage or collapse adjacent structures or excavations.



When operating in an enclosed area, exhaust fumes should be piped outside. Continued breathing of exhaust fumes may prove FATAL.

13. Remove all tools, parts and/or electrical cords before starting the unit.
14. When servicing batteries, do **NOT** smoke and/or use an open flame in the vicinity. Batteries generate explosive gas during charging. There must be proper ventilation when charging batteries.
15. When filling the fuel tank, do **NOT** smoke and/or use an open flame in the vicinity.
16. If abnormal equipment operation is observed, discontinue use immediately and correct the problem.
17. Do **NOT** leave the equipment control pendant (radio control) unattended.
18. Store oily rags in approved containers and away from the engine exhaust system.
19. If running an auger/drill, make sure that the Auger rotation switch is in NEUTRAL before starting the Power Unit engine
20. Do **NOT** adjust and/or set the hydraulic pressures higher and/or lower than those specified in this Manual.
21. NEVER operate this equipment with hydraulic hoses that are damaged or 'kinked'. Replace damaged hoses immediately.
22. Do **NOT** lift and/or support hydraulic hoses with wire rope slings.
23. NEVER attempt to connect Quick Disconnects (QDs) when the Power Unit is running.
24. Do **NOT** pull on and/or attempt to move equipment with the hydraulic hoses.
25. Do **NOT** attempt to locate hydraulic leaks with your hands. High-pressure leaks can penetrate skin and cause severe damage, blood poisoning and/or infection.
26. Do **NOT** attempt to repair leaks while the equipment is in operation.
27. Do **NOT** attempt to tighten and/or loosen fittings and/or hoses when the machine is in operation.
28. Power Unit must always be placed on level, stable ground.

29. Do **NOT** remove Power Unit heat shields. Do NOT attempt to use the Power Unit without heat shields. Severe fires may result.

NOTICE

A properly maintained fire extinguisher, suitable for oil fires, MUST be kept in the immediate vicinity of equipment operations.

30. When moving and/or transporting this equipment, insure that the vehicle and/or vessel is of sufficient capacity to handle the load. Make sure that the equipment is properly tied down.
31. When moving and/or transporting this equipment, be sure that the QD Dust Caps are tight and that the cap safety cables are in place. Be sure that all equipment parts are tight and/or properly secured before shipment. Unsecured parts may vibrate loose and fall during transport causing injury and/or property damage.
32. Rounded and/or damaged bolt heads and/or nuts should be replaced so that proper torque values may be obtained. Proper torque values are necessary to prevent parts on this equipment, leads and/or crane booms from loosening and/or falling. (Refer to the torque chart in this manual for the proper values.)
33. When operating in a closed area, pipe exhaust fumes outside. (Warning: Breathing exhaust fumes can cause serious injury or even death.)
34. When loading or unloading the power unit using a forklift, the forks must be placed under the entire depth of the unit.
35. Keep hands away from rotating flighting auger shaft and/or rotary joint.
36. Do **NOT** allow clothing, hoses, ropes, etc., to be entangled in, or wrap around, rotating flighting, Auger Shaft and /or rotary joint.
37. Never stand under an equipment at any time and keep your eyes on the equipment when it is in operation.

SAFETY SECTION

SAFETY MESSAGES

There may be several specific safety messages on your equipment. The exact location and description of the safety messages are reviewed in this section. Become familiar with all safety messages.

Ensure that all the safety messages are legible. Clean the safety messages or replace the safety messages if the words cannot be read or if the illustrations are not visible. Use a cloth, water and soap to clean the safety messages. Do not use solvents, gasoline, or other harsh chemicals. Solvents, gasoline, or harsh chemicals could loosen the adhesive that secures the safety messages. The safety messages that are loosened could drop off the equipment.

Replace any safety message that is damaged or missing. If a safety message is attached to a part of the equipment that is replaced, install a new safety message on the replacement part. Your APE dealer can provide new safety messages.



Do not operate or work on this equipment unless you have read and understand the instructions and warnings in the Operation and Maintenance Manual. Failure to follow the instructions or read the warnings could result in injury or death. Contact any APE dealer for replacement manuals. Proper care is your responsibility.

QUICK DISCONNECT NOTICE

NOTICE: QUICK DIS-CONNECTS MUST BE FULLY SEATED TO ALLOW FREE HYDRAULIC FLOW. BLOCKED HYDRAULIC FLOW WILL STOP OR SLOW OPERATIONS AND CAUSE EXCESSIVE HEAT. TO SOLVE PROBLEM, REMOVE CLEAN AND RE INSTALL FITTINGS

Make sure all QD's are installed and connected completely. Failing to do so may cause damage or prevent proper operation.

IDENTIFICATION TAG



This information is important when contacting APE for replacement parts or other information.

- * Model
- * Serial No.

HYDRAULIC OIL FULL



Hydraulic oil needs to be kept at correct FULL level at all times. Do **NOT** overfill the tank. This may cause leakage when hot, due to insufficient space for oil to expand. Depending on the power unit it will have either one or two electronic hydraulic sensors to monitor low oil level and oil level shutdown, to prevent damage to the power unit.

DO NOT WELD



Do **NOT** weld on or around the power unit unless authorized in writing by APE. Doing so will void all warranties and may cause damage to the power unit or vibro.

SAFETY SECTION

GENERAL HAZARD INFORMATION



Attach a “Do Not Operate” warning tag to the start switch or controls before the equipment is serviced or repaired. Attach the warning tags to the engine and to each operator control panel. When appropriate disconnect the negative terminal on the battery.

Do not allow unauthorized personnel on the equipment or around the equipment while being serviced.

Cautiously remove the following parts. To help prevent spraying or splashing of pressurized fluids hold a rag over the part that is being removed.

- Filler caps
- Grease fittings
- Pressure taps
- Breathers
- Drain plugs

PRESSURIZED AIR AND WATER

Pressurized air and/or water can cause debris and/or hot water to be blown out which could result in personal injury.

The maximum air pressure for cleaning purposes must be reduced to 30psi (205 kPa) when the air nozzle is deadheaded and used with effective chip guarding (if applicable) and personal protective equipment. The maximum water pressure for cleaning purposes must be below 40psi (275 kPa). When pressurized air and/or pressurized water is used for cleaning, wear protective clothing, protective shoes, and eye protection. Eye

protection includes goggles or a protective face shield. Always wear eye protection for cleaning the cooling system.

Avoid direct spraying of water on electrical connectors, connections, and components. When using air for cleaning, allow the equipment to cool to reduce the possibility of fine debris igniting when redeposited on hot surfaces.

FLUID PENETRATION

Always use a board or cardboard when you check for a leak. Leaking fluid that is under pressure can penetrate body tissue. Fluid penetration can cause serious injury and possible death. A pin hole leak can cause severe injury. If fluid is injected into your skin, you must get medical treatment immediately. Seek treatment from a doctor that is familiar with this type of injury.

CONTAINING FLUID SPILLAGE

NOTICE

Care must be taken to ensure that fluids are contained during performance of inspection, maintenance, testing, adjusting, and repair of the equipment. Be prepared to collect the fluid with suitable containers before opening any compartment or disassembling any component containing fluids.

Dispose of all fluids according to local regulations and mandates.

LINES, TUBES, AND HOSES

Do not bend or strike high-pressure lines. Do not install lines, tubes, or hoses that are damaged.

Repair any fuel lines, oil lines, tubes, or hoses that are loose or damaged. Leaks can cause fires or injury.

Inspect all lines, tubes, and hoses carefully. Do not use bare hands to check for leaks. Always use a board or cardboard for checking equipment components for leaks. Tighten all connections to the recommended torque.

Check for the following conditions:

- End fittings that are damaged or leaking
- Outer covering that is chafed or cut
- Wire that is exposed in reinforced hose
- Outer covering that is ballooning locally
- Flexible part of the hose that is kinked or crushed
- Armoring that is embedded in the outer covering

Ensure that all of the clamps, guards, and heat shields are installed correctly. Correct installation of these components will help to prevent these effects: vibration, rubbing against other parts and excessive heat during operation.

INHALATION

Exhaust fumes can be hazardous to your health. If you operate the equipment in an enclosed area, adequate ventilation is necessary,

BURN PREVENTION

Do not touch any part of the equipment during operation. Allow the equipment to cool before any maintenance is performed on the engine. Relieve all pressures in the hydraulic system, fuel system, lubrication system, or cooling system before any lines, fittings, or related items are disconnected.

COOLANT

When the engine is at operating temperature, the engine coolant is hot. The coolant is also under pressure. The radiator and all lines to the heaters or to the engine contain hot coolant. When pressure is relieved rapidly, the hot coolant can turn into steam.

Any contact with hot coolant or with steam

can cause severe burns. Allow cooling system components to cool before the cooling system is drained.

Check the coolant level only after the engine has been stopped.

Do not step on the engine in order to remove the filler cap. Ensure that the filler cap is cool before removing the filler cap. Remove the filler cap slowly in order to relieve pressure.

Cooling system conditioner contains alkali. Alkali can cause personal injury. Do not allow alkali to contact the skin, the eyes, or the mouth.

OIL

Hot oil and hot components can cause personal injury. Do not allow hot oil or hot components to contact the skin.

Keep all of the exhaust manifold and turbocharger heat shields in place in order to protect components from oil spray if there is a failure of a line, tube, or seal.

BATTERIES

The battery electrolyte is acidic. Battery acid can cause personal injury. Do not allow battery acid to come in contact with the skin or the eyes. Always wear protective glasses for servicing batteries. Wash hands after touching the batteries and connectors. The use of gloves is recommended.

Batteries give off combustible gases which can explode. Ensure proper ventilation for batteries that are in an enclosure. Never disconnect any charging unit circuit or battery circuit cable from the battery when the charging unit is operating. A spark can cause the combustible gases to ignite. Do not smoke when batteries are serviced.

Always thaw a frozen battery before jump starting the battery. Frozen batteries can explode.

SAFETY SECTION

CRUSHING PREVENTION AND CUTTING PREVENTION

Support the equipment properly when work beneath the equipment is performed.

Unless other maintenance instructions are provided never attempt adjustments while the engine is running.

Stay clear of all rotating parts and moving parts. Leave the guards in place until maintenance is performed. After the maintenance is performed reinstall the guards.

Keep objects away from moving fan blades. The fan blades will throw objects or cut objects.

Wear protective glasses in order to avoid injury to the eyes.

Chips or other debris may fly off objects when objects are struck. Before objects are struck, ensure that no one will be injured by flying debris.

MOUNTING AND DISMOUNTING

Do not climb on the equipment, and do not jump off the equipment. Do not stand on the components which can not support your weight. Mount the equipment and dismount the equipment only at locations that have a ladder or handholds.

BEFORE STARTING ENGINE

Inspect the engine for potential hazards.

All protective guards and all protective covers must be installed if the engine must be started in order to perform service procedures. To help prevent an accident that is caused by parts in rotation, work around the parts carefully.

Do not bypass the automatic shutoff circuits. Do not disable the automatic shutoff circuits. The circuits are provided in order to help prevent

personal injury and equipment damage.

On the initial start-up of a new engine or an engine that has been overhauled, be prepared to stop the engine if a problem occurs.

ENGINE STARTING

If a warning tag or do not operate tag is attached to the engine start switch or to the controls, DO NOT start the engine or move the controls. Consult with the person that attached the warning tag before the engine is started.

All protective guards and all protective covers must be installed if the engine must be started in order to perform service procedures. To help prevent an accident that is caused by parts in rotation, work around the parts carefully.

Start the engine from the operator's panel or remote pendant start switch.

Always start the engine according to the procedure that is described in this Operation and Maintenance Manual, "Engine Starting" topic (Operation Section). Knowing the correct procedure will help to prevent major damage to the engine components. Knowing the procedure will also help to prevent personal injury.

Engine exhaust contains products of combustion that can be harmful to your health. Always start and operate the engine in a well ventilated area. If the engine is run in an enclosed area, vent the engine exhaust outside.

ENGINE STOPPING

Stop the engine according to the procedure in the Operation and Maintenance Manual, "Engine Stopping (Operation Section)" in order to avoid overheating of the engine and accelerated wear of the engine components.

Use the Emergency Stop Button ONLY in an

emergency situation. **Do not use the Emergency Stop Button for normal engine stopping.** After an emergency stop, DO NOT start the engine until the problem that caused the emergency stop has been corrected.

Stop the engine if an overspeed condition occurs during the initial start-up of a new engine or an engine that has been overhauled. This may be accomplished by shutting off the fuel supply to the engine and/or shutting off the air supply to the engine.

To stop an electronically controlled engine, cut the power to the engine.

ELECTRICAL SYSTEM

Never disconnect any charging unit circuit or battery circuit cable from a battery when the charging unit is operating. A spark can cause the combustible gases that are produced by some batteries to ignite.

If the engine must be started by an external electrical source, then always connect the positive jump start cable "+" to the positive terminal "+" of the battery.

To help prevent sparks from igniting combustible gases that are produced by some batteries, the negative "-" jump start cable should be connected last from the external power source to the negative "-" terminal of the starting motor. If the starting motor is not equipped with a negative "-" terminal, connect the jump start cable to the engine block.

GROUNDING PRACTICES

Proper grounding for the equipment electrical system is necessary for proper engine performance and reliability. Improper grounding will result in uncontrolled electrical circuit paths and unreliable electrical circuit paths.

Uncontrolled equipment electrical circuit paths

can result in damage to the engine and pumps. All grounds should be tight and free of corrosion. The alternator and the starting motor must be grounded to the negative "-" battery terminal.

A grounding strap must be used for all equipment that has an alternator grounded to an engine component. The ground strap must be connected to the component and to the negative "-" battery terminal. The component must be electrically isolated from the engine.

A ground plate with direct path to the negative battery terminal "-" can be used as a common ground point for the components of one engine system.

When servicing a power unit, make sure to disconnect both battery cables starting with the ground wire from the negative terminal on the battery. Not disconnecting the battery can cause damages to the ECM, fees will apply, warranties will be voided.

ENGINE FILTERS

Use only CAT Filters. Using other filters will damage the engine, Fees will apply and warranty will be voided

PRODUCT INFORMATION SECTION

Equipment Overview

GENERAL INFORMATION

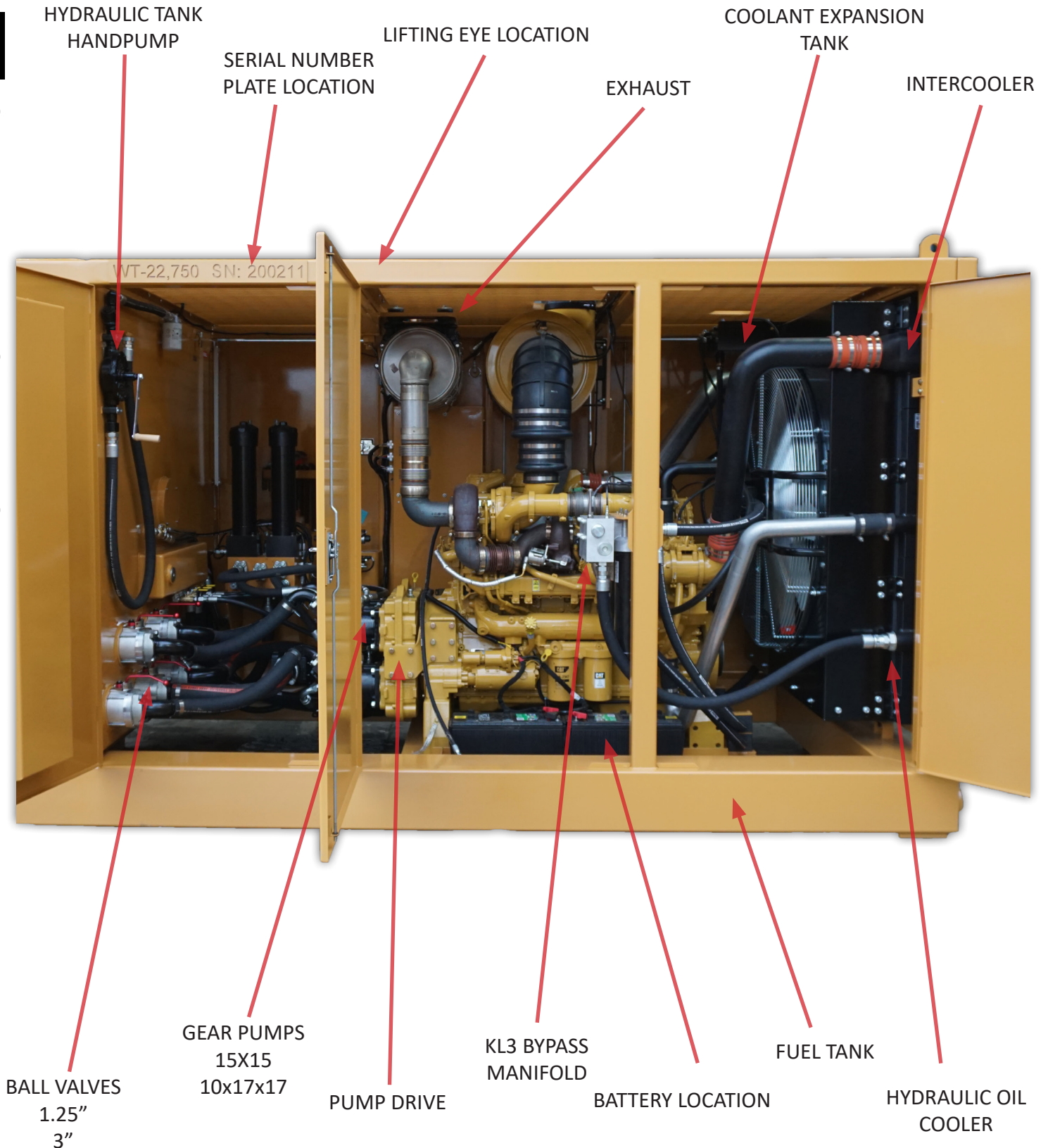

PRODUCT INFORMATION SECTION

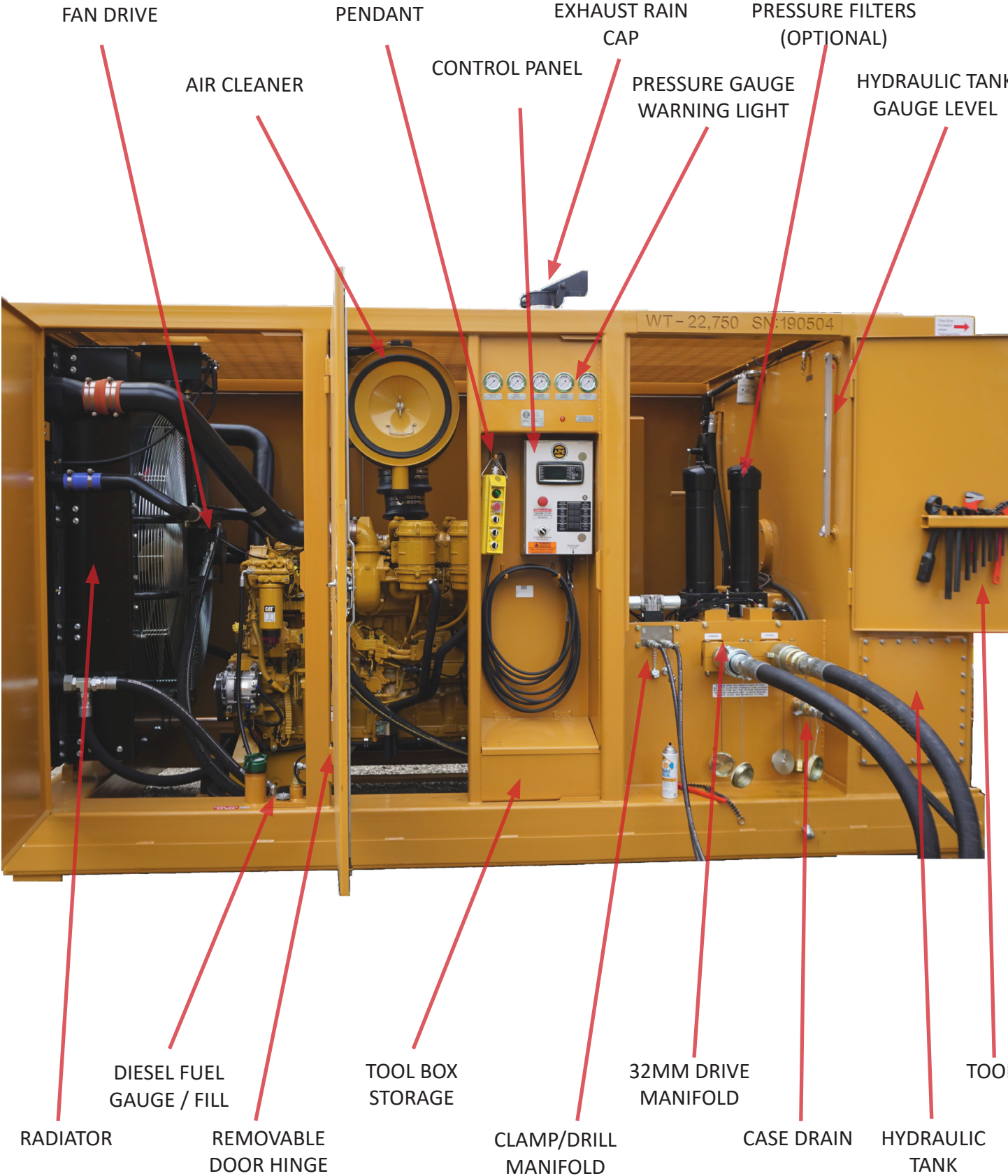

GENERAL INFORMATION



OPERATION SECTION

Lifting and Storage

Always load the power unit with the hydraulic tank facing the front of the truck, to prevent damage to the cooler and radiator from flying debris. When lifting the power unit, position the forklift forks forward as far as possible to prevent load shifts. See Photo.



Connecting the Hydraulics

Connecting the hoses is one of the most critical aspects of commissioning an APE tool.

Take extreme care to keep these connections absolutely clean. This procedure is one of the most common ways for foreign particles to be introduced into a hydraulic system.

To connect the tool to the power unit:

1. Turn the power unit OFF.
2. Position power unit close enough to work that hoses will be able to reach.

- Most hose failures are caused by pulling hoses off couplers. Avoid pulling on hoses.
3. Clean all quick disconnects with brakewash. They must be completely free of dirt or contaminants.
 4. Attach quick disconnects. Note that quick disconnects of each hose type are mated to prevent backwards hookups.
 5. Tighten all fittings to hand tightness. Verify with chain wrench.
 - DO NOT OVERTIGHTEN

New hydraulic fluid is NOT clean oil!

***Oil must meet ISO cleanliness code
17/15/11***

Please do the following:

- Set the engine at idle
- Run at idle for about 10 minutes to fill the lines
- Drive will not engage until the power unit is up to operating temperature.

Attention!

Pressurizing the system while there is air entrained in the fluid may cause damage to the components.

Let the system run at idle for an **additional 10 minutes** to allow the air to rise into the airspace of the hydraulic reservoir.

Connecting the Hydraulics

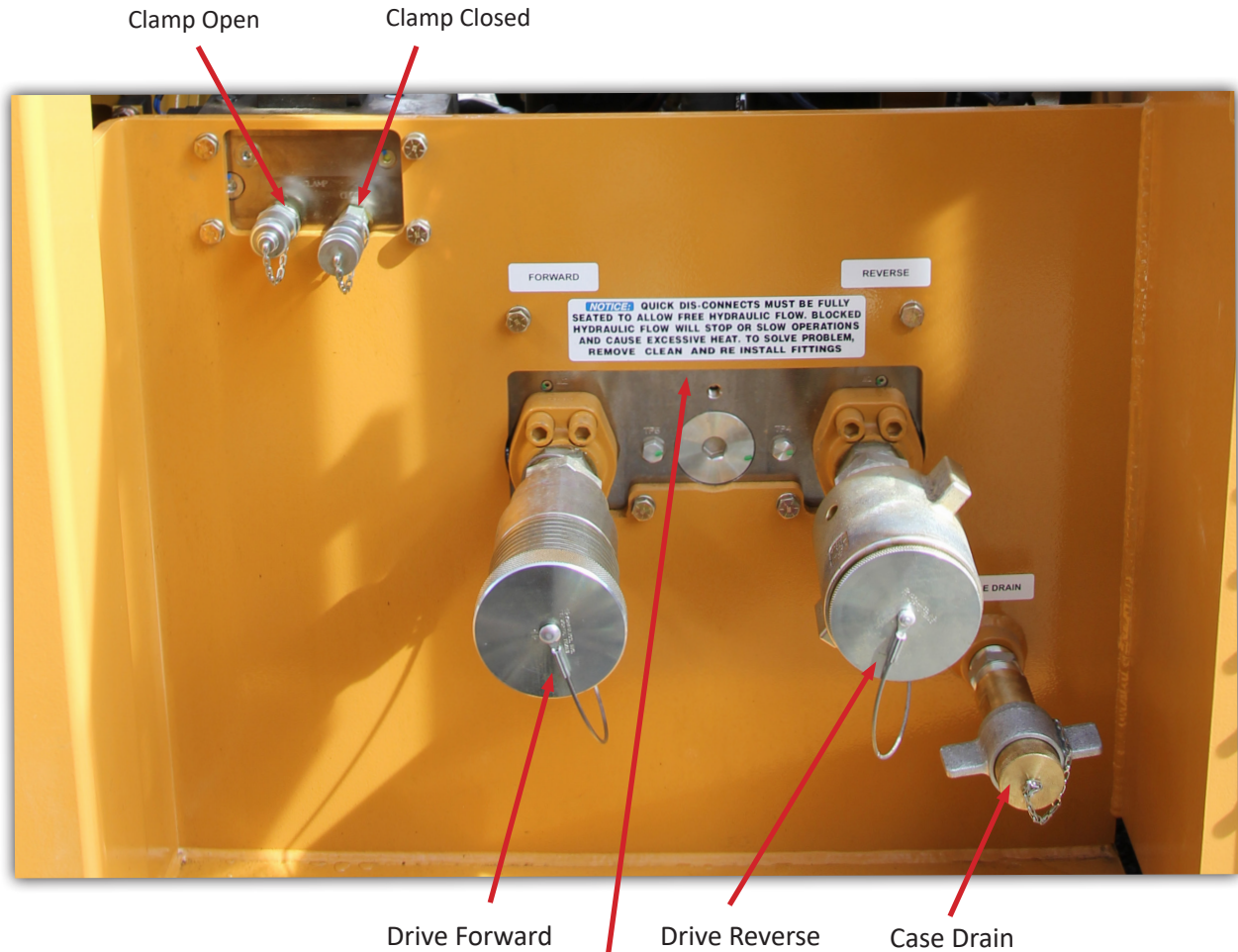

NOTICE: QUICK DIS-CONNECTS MUST BE FULLY SEATED TO ALLOW FREE HYDRAULIC FLOW. BLOCKED HYDRAULIC FLOW WILL STOP OR SLOW OPERATIONS AND CAUSE EXCESSIVE HEAT. TO SOLVE PROBLEM, REMOVE CLEAN AND RE INSTALL FITTINGS

Start / Warm Up Procedure

Before operation it is necessary to bring the power unit's hydraulic oil and coolant to a working temperature. To start and warm up the power unit follow the steps below:

1. On the main control panel, turn main power switch to the ON position.
2. Press and hold engine START/STOP button until engine in running. This should only take a few seconds.
3. Power unit will idle at 1200 RPM until the coolant reaches 100°F. Failing to do this may cause seal failures, leaks and excessive pressures through the hydraulic system.

Operating Temperatures

The Operating Temperature references the internal temperature of the engine.

Take into consideration the following requirements:

- 70°C (158°F) – Avoid going over this Operating Temperature for improved service life
- 75°C (168°F) – Highest permissible intermittent Operating Temperature
- -35°C (-31°F) – Lowest permissible Operating Temperature

Control Panel Gauges



CLAMP OPEN / CLOSE

Clamp open/close shows the pressure being applied to the clamp circuit when opening or closing the clamps. This clamp closed pressure should be set at 4500 psi for safe operation. Clamp open should be set at 4800 psi.

HYDRAULIC COOLER PRESSURE

The hydraulic gauge shows the pressure when the hydraulic oil is recirculating through the cooler. This can be used as a indication tool for when the filter need to be replaced if the pressure starts to increase.

DRIVE FWD / REV PRESSURE

The Drive pressure gauge shows the pressure while the power unit is driving the application in forward or reverse. This should be set at 5000 PSI while the drive is energized.

FAN MOTOR PRESSURE

The fan motor pressure gauge shows the pressure while the hydraulic fan is being driven. Normal fan pressure should be 2600psi when the power unit is up to temperture

HYDRAULIC OIL LOW

When the warning light comes on, that means you are low on hydraulic oil and will need to top off the hydraulic tank.

You can fill hydraulic oil through the Hand pump

APE PART NUMBER	PART NUMBER	DESCRIPTION
513007	25-310-7500-PSI/BAR-CFF	Gauge-2.5 LBM-SG-0-7500PSI
CONTACT FACTORY	25-310-6000-PSI/BAR-CFF	Gauge-2.5 LBM-SG-0-6000PSI
CONTACT FACTORY	25-310-600-PSI/BAR-CFF	Gauge-2.5 LBM-SG-0-600PSI

Control Panel Overview

GENERAL INFORMATION

ATTENTION:

WILL SHUT OFF ENGINE, DISENGAGE DRIVE AND ALL VALVES INSTANTLY.
Control panel will stay on.



EMERGENCY ENGINE STOP

Engine Start / Stop

Drive Reverse

Clamp Open

Speed Hi/Low

Panel Power

Drive Forward

Clamp Close

Panel / Pendant Selection



To Select Menu Option

Governor

Selection Button

Inactive Button



Note: The color of the light does not matter, Some Keypads are all green or mix with red.
Please call 1-800-248-8498 to have an A.P.E Certified Technican to enable functions.





ATTENTION:

WILL SHUT OFF ENGINE, DISENGAGE DRIVE AND ALL VALVES INSTANTLY.

Control panel will stay on.

POWER

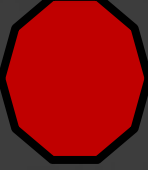

E-STOP

EMERGENCY ENGINE STOP

EMERGENCY USE ONLY

Do not use unless it's an emergency.

This will shut off the engine, disengage drive and all valves instantly. The control panel power will stay on.

Clamp will stay closed but will not stay energized unless the emergency stop is disengaged.

CONTROL PANEL POWER ON / OFF

This will turn the power on to the control panel. The power must be on to run the unit.

Note: The color of the light does not matter, Some Keypads are all green or mix with red. Please call 1-800-248-8498 to have an A.P.E Certified Technican to enable functions.





ENGINE, HYDRAULICS, & DIAGNOSTIC SCREEN VIEWS

Display to view Engine Rpm, Hydraulic pressure, and Diagnostic screen. See Page 28.

ENGINE RPM GOVERNOR

Spin right to increase engine RPM in increments of 50. Press the knob then spin right to reach max engine RPM instantly.

Spin left to decrease engine RPM in increments of 50. Press the knob then spin left to reach min engine RPM instantly.

ENGINE START / STOP

If the control panel is powered on, this button will start the engine. You must hold the button down until the engine fully starts.

To stop the engine, press this button again for a short second.

NOTE: Before shutting off the engine, run at 800 RPM idle for at least 1 minute.





DRIVE REVERSE

This will pump oil backwards out of the reverse line into the drive forward line. This is used to fill the hoses with oil or to test a line to make sure the QD is properly connected. If a QD is not connected, the pressure on this line will high max.



DRIVE REVERSE ON

This will start pumping oil out of the reverse line circuit

DRIVE FORWARD

This button will pump oil into the drive forward line, getting the hammer to vibrate.



DRIVE FORWARD ON

This will start pumping oil out of the forward line circuit

Note: The color of the light does not matter, Some Keypads are all green or mix with red.
Please call 1-800-248-8498 to have an A.P.E Certified Technician to enable functions.



GENERAL INFORMATION

GENERAL INFORMATION

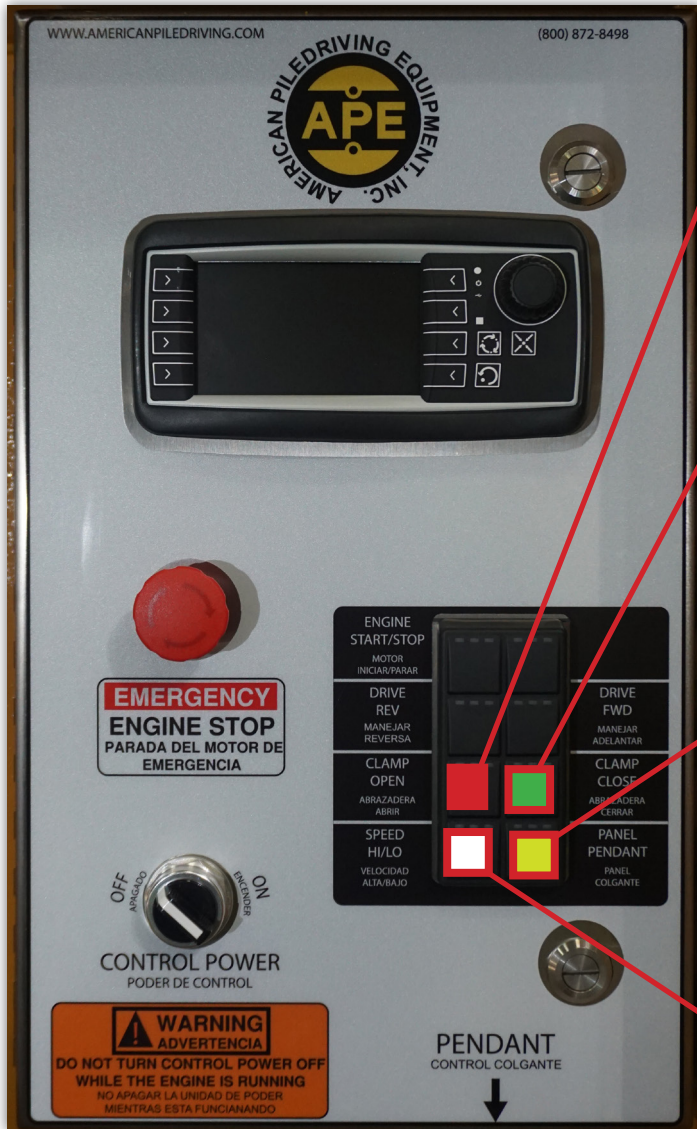

CLAMP OPEN



This button opens the clamp



CLAMP CLOSE



This button closes the clamp.

PANEL / PENDANT MODE SELECTION



This button allows you to switch the control functions between the panel control and pendant.

PANEL	PENDANT
	

NOTE: LED Position indicator

DRILL SPEED HI/LO

This button allows you switch drill speed between Hi or low speed.

HIGH	LO
	

NOTE: IF EQUIPPED

Note: The color of the light does not matter, Some Keypads are all green or mix with red.
Please call 1-800-248-8498 to have an A.P.E Certified Technican to enable functions.



Wireless Pendant *OPTIONAL*

FEATURES

- Wireless Remote
- USB Magnetic Charging Dock
- Range Distance up to 600'
- Rugged Heavy Duty
- Ergonomic Handheld
- Waterproof
- Shockproof
- High-Impact Rated
- Engine Display
- Hydraulic Display
- Extended Battery Life

POWER / EMERGENCY STOP

ATTENTION:

WILL SHUT OFF ENGINE, DISENGAGE DRIVE AND ALL VALVES INSTANTLY.

Control panel will stay on.



GENERAL INFORMATION

GOVERNOR

DECREASE ENGINE RPM
Press to decrease RPM by increments of 50 RPM. Hold for Min RPM.

DRIVE REVERSE

Press DRIVE REV button to ENGAGE
ENABLE BUTTON REQUIRED
Press DRIVE REV button again to disengage

CLAMP OPEN

Press CLAMP OPEN button to ENGAGE
(MOMENTARY)
ENABLE BUTTON REQUIRED

DRILL HIGH/LOW

Press DRILL HIGH / LOW to toggle between modes.
ENABLE BUTTON REQUIRED

ATTENTION

ENABLE BUTTON

Must be depressed to activate a function:
ENGINE START
DRIVE FWD
DRIVE REV
CLAMP OPEN
CLAMP CLOSE
DRILL HIGH/LOW

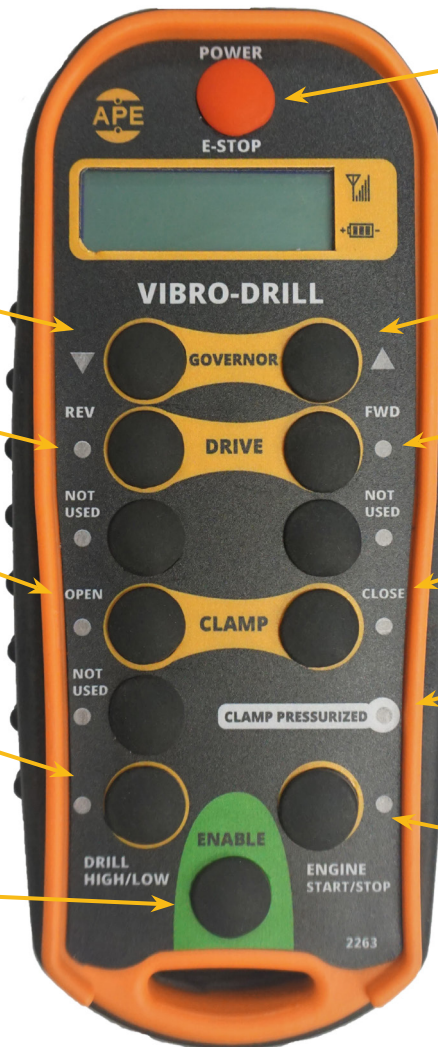

GOVERNOR

INCREASE ENGINE RPM
Press to increase RPM by increments of 50 RPM. Hold for Max RPM.

DRIVE FORWARD

Press DRIVE FWD button to ENGAGE
ENABLE BUTTON REQUIRED
Press DRIVE FWD button again to disengage

CLAMP CLOSE

Press CLAMP CLOSE button to ENGAGE / DISENGAGE **(MAINTAIN)**
ENABLE BUTTON REQUIRED

CLAMP PRESSURIZED

NOTE: BLUE LED = CLAMP PRESSURE is ACTIVE

ENGINE

START/STOP START

Press Engine Start button to start.
ENABLE BUTTON IS REQUIRED

STOP

Press Engine Stop button to shut down the engine.

NOTE: "WHILE DRIVING" If remote is out of range, Drive will go into neutral, Engine rpm will decrease to idle, and if clamp is active, clamp will stay closed.



GENERAL INFORMATION

Control Panel Display

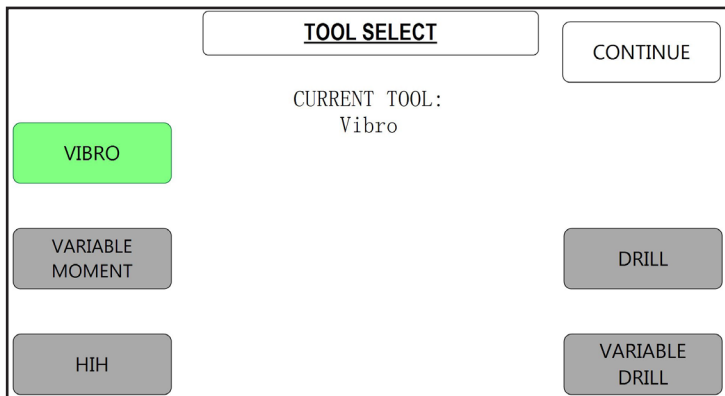

This screen is displayed on boot-up, and the default tool for the machine is already colored in green. Press 'CONTINUE' or select a different tool and then press 'CONTINUE' to advance to the confirmation screen. It is critical that the correct tool is selected, as important machine functions are tied to which tool is chosen at this screen. Typically, the default selected tool should be correct, and in that case it is only necessary to press 'CONTINUE'.



This is the conformation screen. Verify that the correct tool is indicated, and press 'CONFIRM' on that screen to be taken to the page for that specific tool. The machine can only be operated after tool selection has been confirmed.

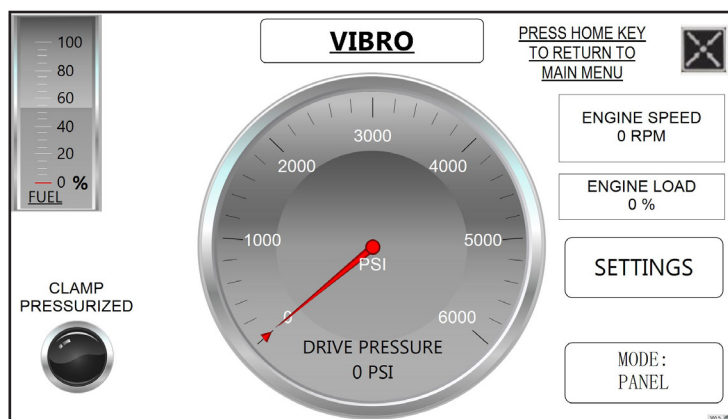

This is the primary screen for the Vibro tool and shows information most relevant to operating a vibratory hammer. The only active buttons on this page are the 'HOME' key as indicated and the button for navigating to the vibro 'SETTINGS' page.

When in 'PANEL' mode the start, drive, and clamp functions are controlled by the keypad on the control panel. When 'PENDANT' mode these functions are controlled by a remote pendant.

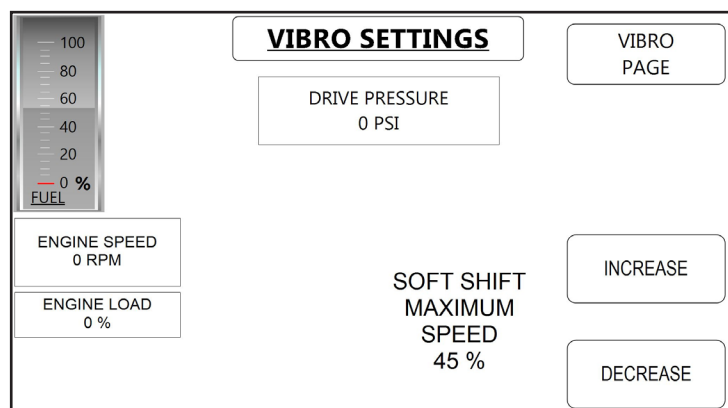

This page allows for increasing and decreasing the soft shift ramp up time for the vibratory hammer. Increasing this percentage will make the soft shift valve ramp up more slowly. Decreasing this percentage will make the soft shift valve ramp up more quickly.

The only other button active on this page is the button to return to the main 'VIBRO' page.

GENERAL INFORMATION

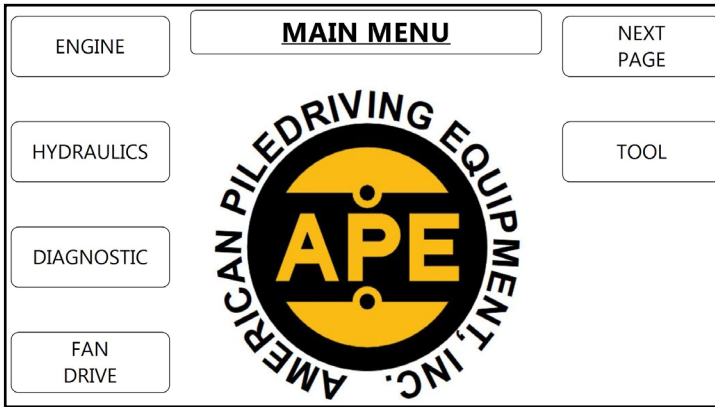

The main menu screen is used to easily navigate to the other display screens for this system as indicated by the button labels shown in the above image. The 'TOOL' page button will switch the screen to whichever page is for the currently selected tool (among the pages shown previously in this manual).

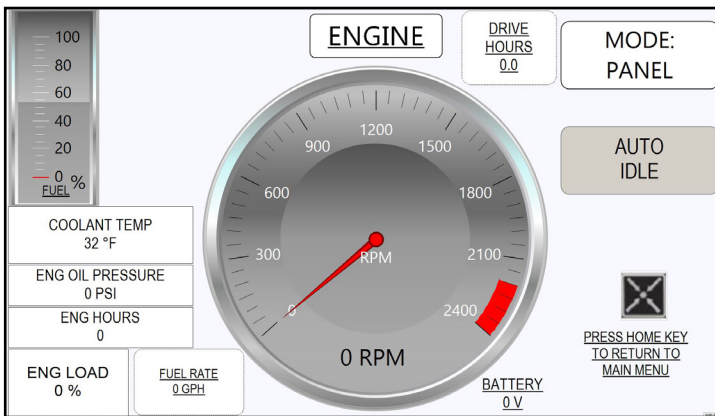

This page shows relevant engine information and allows an operator to toggle auto-idle on and off with the 'AUTO IDLE' button. The button label will be green when auto-idle is enabled.

The auto-idle feature takes control of the engine governor and automatically increases RPM when a valve is being energized. If all valves are de-energized the engine RPM automatically decreases to idle. This allows an operator to ignore governor control and has the potential to save fuel.

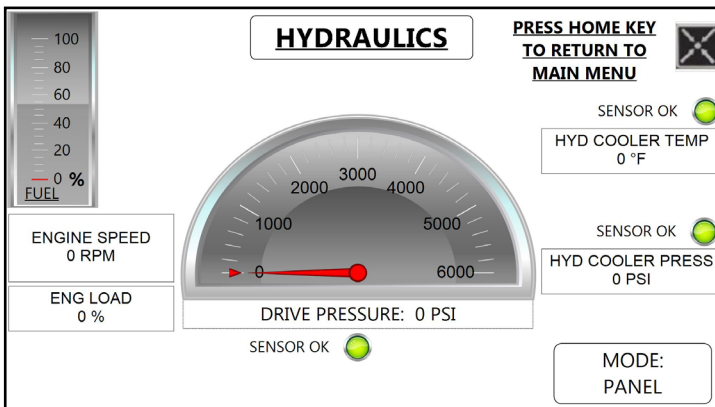

This page shows relevant hydraulic information and has no active buttons besides the indicated 'HOME' key to return to the main menu.

The hydraulic cooler temperature and pressure sensors will report on this screen whether the sensor is 'OK' or has a 'FAULT' as well as if the sensor is no present.

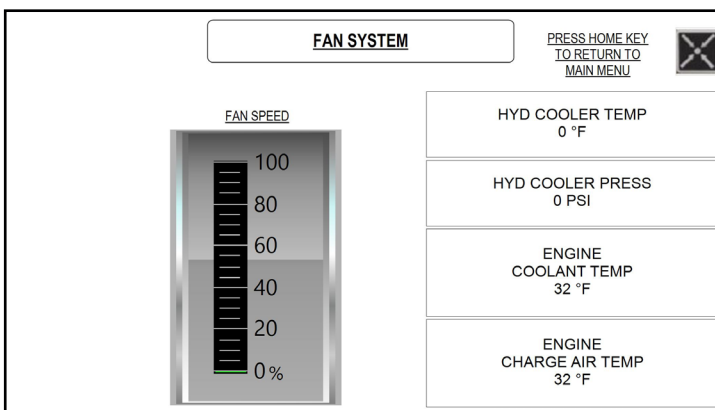

This page shows information relevant to the fan cooling system. The fan cooling system is a three-zone system which monitors hydraulic oil temperature, engine coolant temperature, and engine charge air temperature. Each of these temperature parameters has a range within which they will request fan speed between 0% to 100% depending on where that parameter is in the window. The resulting fan speed will be determined by whichever parameter is requesting the highest speed.

GENERAL INFORMATION

This page indicates the status of the hydraulic system sensors as well as the air filter. Not all systems will have all of the sensors shown here, and when a sensor is not present then it will be grayed out and say <NOT USED> instead of showing the status.

Filters, when clogged, will say 'CLOG' instead of 'OK' and show a red LED instead of green. Hydraulic level sensors may, optionally, include low level warning in addition to the very low level shutdown sensor. Hydraulic fluid temperature sensors may optionally include low temperature warnings and high temperature warnings as well as a very high temperature shutdown sensor. In some systems the very high temperature shutdown is triggered by a switch. In others it is triggered by the temperature transmitter which is part of the optional cooler pressure transmitter.

If one of these sensors trips then a warning screen will be shown with a large flashing red LED, and on that screen the operator must confirm the error after which this 'DIAGNOSTIC' page will be shown. If the screen is on a working page which contains valve controls then the warning screen will wait to pop up until after the operator has left the working page.

The only other buttons active on this page is the button to return to the main menu and the button to navigate to the next 'DIAGNOSTIC' page which contains engine fault icons.

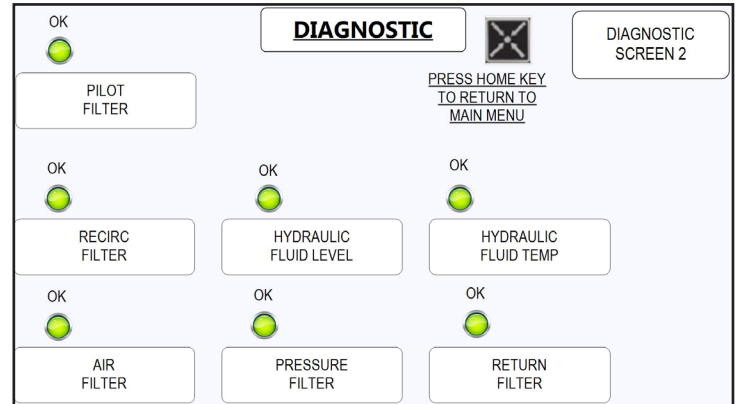

GENERAL INFORMATION

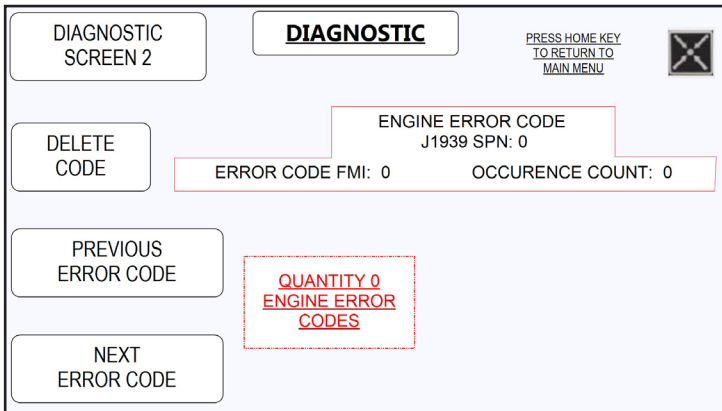

This page shows numeric engine error codes. These are typically standardized J1939 codes, so information on these codes can often be found with a simple internet search. Buttons on the left side of the screen are used to toggle through if there are multiple codes and to delete / clear a code.

Many codes will return after being deleted or after a power cycle if the error condition is still present.

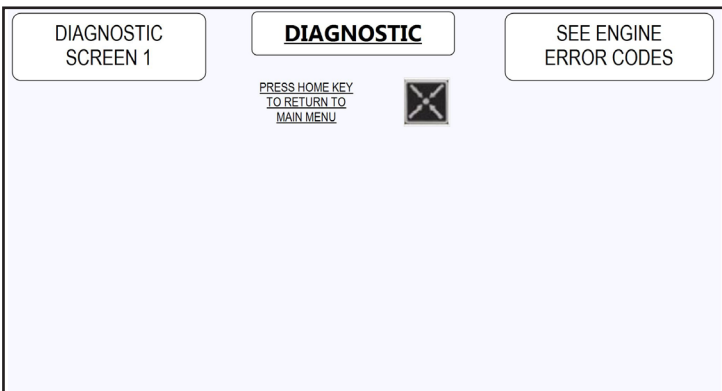

This page includes a readout of different engine errors. When no errors are present no icons will be shown. The lower part of the page will simply be blank. These icons and error names are designated by the engine manufacturer.

Please consult the engine manufacturer's representative or documentation for troubleshooting any of these errors.

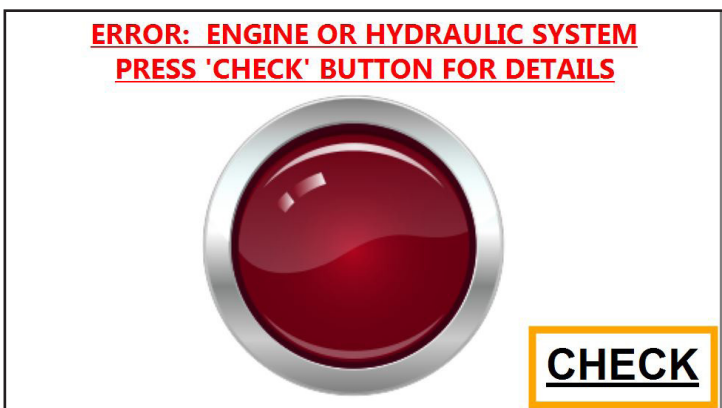

The ERROR screen only appears when there is a trouble code or when one of the sensors fails to send a signal. On the bottom right of the screen the "CHECK" button will take you to the diagnostic screen where the trouble code can be checked and resolved. To return to the main display screen push the "CHECK" button then the "X" button on the diagnostic screen.

MAINTENANCE

Maintenance Chart

DAILY	WEEKLY	250 HOURS OR 6 MONTHS	1500 HOURS OR 1 YEAR	3000 HOURS OR 2 YEARS	6000 HOURS OR 3 YEARS
<ul style="list-style-type: none"> • Check operator's report • Check oil and bring to correct level • Check coolant and bring to correct level • Visually inspect fan • Visually inspect engine for damage, leaks, loose or frayed belts and correct or record for future action • Drain fuel-water separator 	<ul style="list-style-type: none"> • Check air intake system for wear points or damage to piping, loose clamps, and leaks. • Check air cleaner restriction • Check and clean air cleaner element • Drain moisture from tanks 	<ul style="list-style-type: none"> • Change lubricating oil • Change lubricating oil filters • Change fuel filter • Clean crankcase breather • Check engine coolant concentration level • Replace final fuel filter/clean primary fuel filter. Drain water from fuel tank • Inspect/replace alternator fan and accessory drive belts • Inspect/replace hoses and clamps • Lubricate fan drive bearings • Clean/check battery electrolyte level • Inspect return filter, replace element if necessary 	<ul style="list-style-type: none"> • Adjust valves and injectors • Steam clean engine • Check torque on turbocharger mounting nuts • Check torque on engine mounting bolts • Replace hoses as required • Check/adjust engine valve lash • Check/adjust low idle speed • Test/exchange fuel injection nozzles • Inspect/rebuild alternator • Inspect return filter, replace element if necessary 	<ul style="list-style-type: none"> • Clean cooling system and change coolant and antifreeze • Inspect Temperature regulator • Inspect/rebuild turbocharger • Inspect/rebuild starter 	<ul style="list-style-type: none"> • Clean and calibrate the following: <ul style="list-style-type: none"> • -Injectors • -Fuel pump • -Fan Clutch • -Water pump • -Fan Hub • -Fan idler pulley assembly • -Vibration dampener
<p>Follow the manufacturer's recommended maintenance procedures for the starter, alternator, batteries, electrical components, and fan clutch.</p> <p>At each scheduled maintenance interval preform all previous checks which are due for scheduled maintenance.</p>					

MAINTENANCE



Engine Oil

Change engine oil every 250 hours or 6 months, whichever occurs first. Oil should be replaced with Caterpillar 15W-40.

Engine Oil Filter

Change engine oil filter every 250 hours or 6 months, whichever occurs first. Only Cat filters should be used. Any other filters will cause damages to the engine, fees will apply, warranty will be voided.

Hydraulic Oil

When adding or changing hydraulic fluid, APE uses only Biodegradable Envirologic 146 hydraulic fluid, which is not-toxic and will not harm soil or water, and is biodegradable. Consult your local oil supplier for recommendations on mixing hydraulic oils. Change hydraulic oil if it looks milky; this is an indication that water or other contamination may have occurred.

NOTE: Current Hydraulic Oil Type:

Envirologic Hydraulic 146

Air Cleaner Replacement

Check and clean the air cleaner weekly. If the air cleaner needs to be replaced, replace only with Caterpillar filter. Warranty may be void using other filters.

Return Filter Elements

Change all filters every 500 working hours, 2 years or when indicated dirty, whichever occurs first. To change the return filter element follow the steps below:

1. Shut down power unit.
2. Place warning tag on control panel so that the power unit is not started while filters are being replaced.
3. Disconnect negative battery cable.
4. Clean area around filters so that when they are removed there is no chance of introducing dirt into the hydraulic system.
5. Using a 1-1/4 wrench or socket, turn the filter counter-clockwise and spin the filter element off the filter housing.
6. Install new clean filter making sure the spring and o-ring are in the proper place.



Preventative maintenance includes normal servicing that will keep the power unit in peak operative condition and prevent unnecessary trouble from developing. This servicing consists of periodic lubrication and inspection of moving parts and accessories of the unit.

Lubrication is an essential part of preventative maintenance controlling, to a great extent, the useful life of the unit. Different lubricants are needed and some components in the unit require more frequent lubrication than others. Therefore, it is important that the instructions regarding types of lubricants and frequency of their application be closely followed.

To prevent minor irregularities from developing into serious conditions that might involve shutdown and major repair, several other services or inspections are recommended for the same intervals as the periodic lubrications. The purpose of these services or inspections is to assure the uninterrupted operation of the unit.

- Thoroughly clean all lubrication fittings, caps, filler and level plugs along with their surrounding surfaces before servicing
- Prevent dirt from entering in with lubricants and coolants

The intervals given in the schedule are based upon normal operation.

Perform these services, inspections, etc., more often as needed for operation under abnormal or severe conditions.

Storage

During short-term storage of a power unit, the following should be taken into consideration:

- Cover any pressure openings and open threaded holes with suitable caps
- Protect the unpainted surfaces from dirt and moisture
- The power unit should not be stored in an area with substances that have an aggressive corrosive nature; i.e., solvents, acids, alkalies and/or salts

For long-term storage (over 9 months), the following additional actions are recommended:

- Damages to surface paint must be repaired before item is stored
- Protect the unpainted surfaces with suitable anti-corrosion treatment such as CRC SP-350, CorrosionX corrosion inhibitor, or WD-40 Long Term Corrosion Inhibitor
- Fill the power unit completely with hydraulic fluid



If these instructions are followed to the letter, the power unit may be stored for approximately 2-years. However, as storage conditions do have a significant effect, all suggested time frames should be considered as guide values only.

Understanding the Hydraulic System



It is imperative that the hydraulic fluid is kept clean to a minimum ISO Code

17/15/11

New hydraulic fluid is NOT clean oil

See attached document “Understanding ISO Codes” under the Reference / Notes Section

See Warranty document regarding fluid cleanliness at the beginning of this manual

Bulk oil does not typically meet the cleanliness standards required by APE equipment.

For Power Units Powering Helical Drills

- Pressure filters: Clean the hydraulic fluid going to the drill motor and manifold in the forward and reverse directions.
- M1/M2 DRIVE
- LS LOAD SENSE
- 10/11: RDFA-LCN is a direct acting relief valve that is used to protect hydraulic components from pressure variants.
- 8/16/5/19 COILS
- T1 / PD: Both of these ports return to tank.

Electrical System

The electrical system is a normally closed circuit, and runs a self diagnostic test when the panel is powered on. If there is a fault in the electrical system an error screen will appear on the control panel display.

Hydraulic Schematic

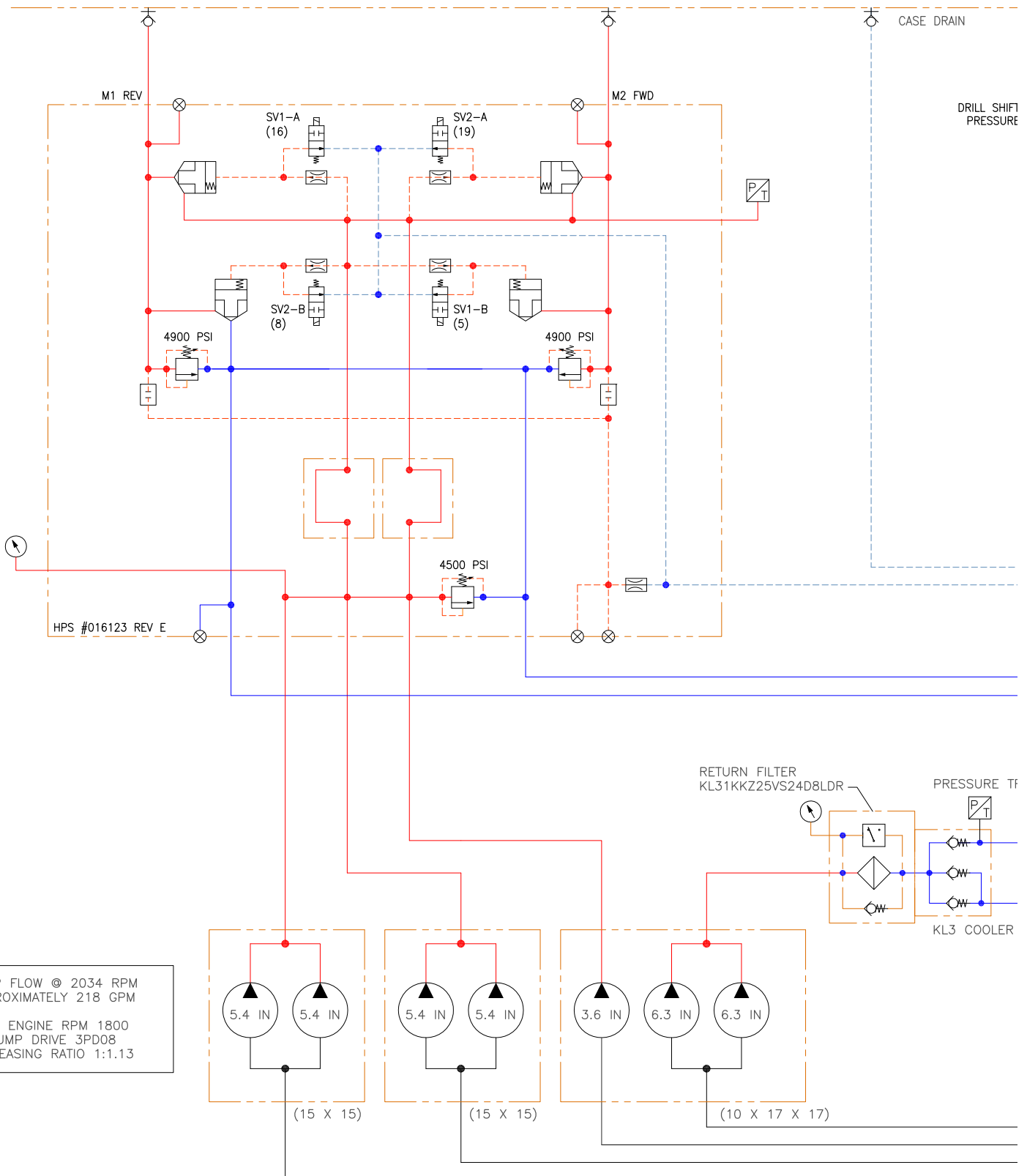

PUMP FLOW @ 2034 RPM
APPROXIMATELY 218 GPM

MAX ENGINE RPM 1800
PUMP DRIVE 3PD08
INCREASING RATIO 1:1.13

TROUBLE SHOOTING



TROUBLESHOOTING

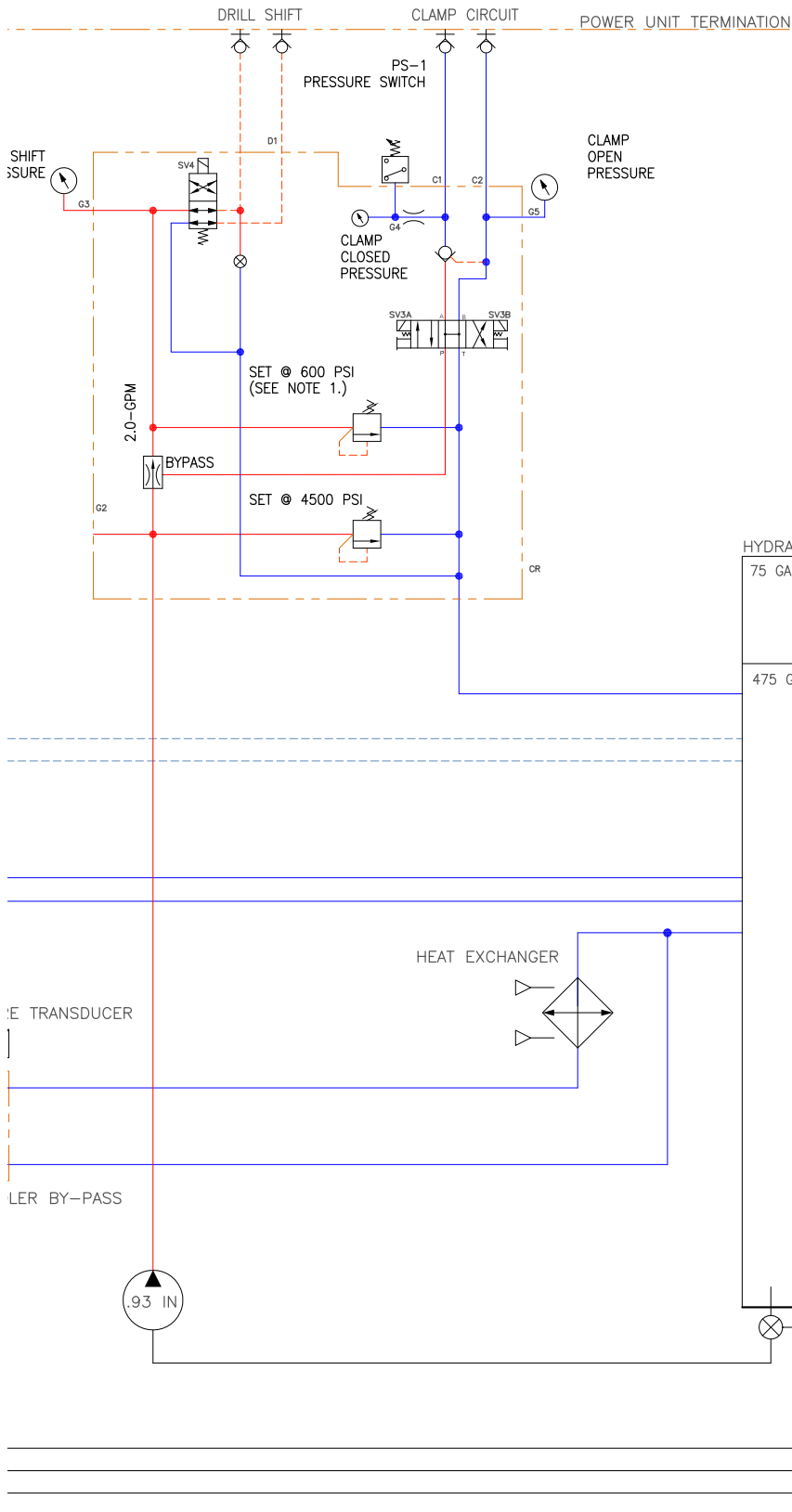

FILTERS:

RF1 RECIRCULATION FILTER CLOGGED

CONTROLS:

- 1 ENGINE START/STOP
- 2 DRIVE FWD
- 3 DRIVE FWD
- 4 CLAMP OPEN
- 5 CLAMP CLOSE
- 6 SPEED HIGH/LOW
- 7 LOCAL/REMOTE

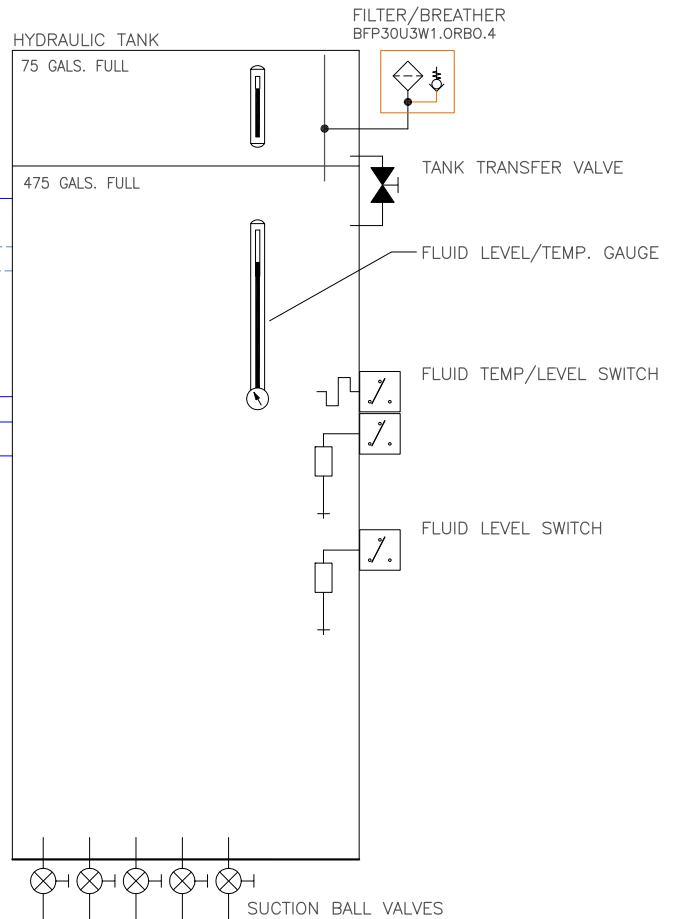

TROUBLE SHOOTING



Electrical Schematic

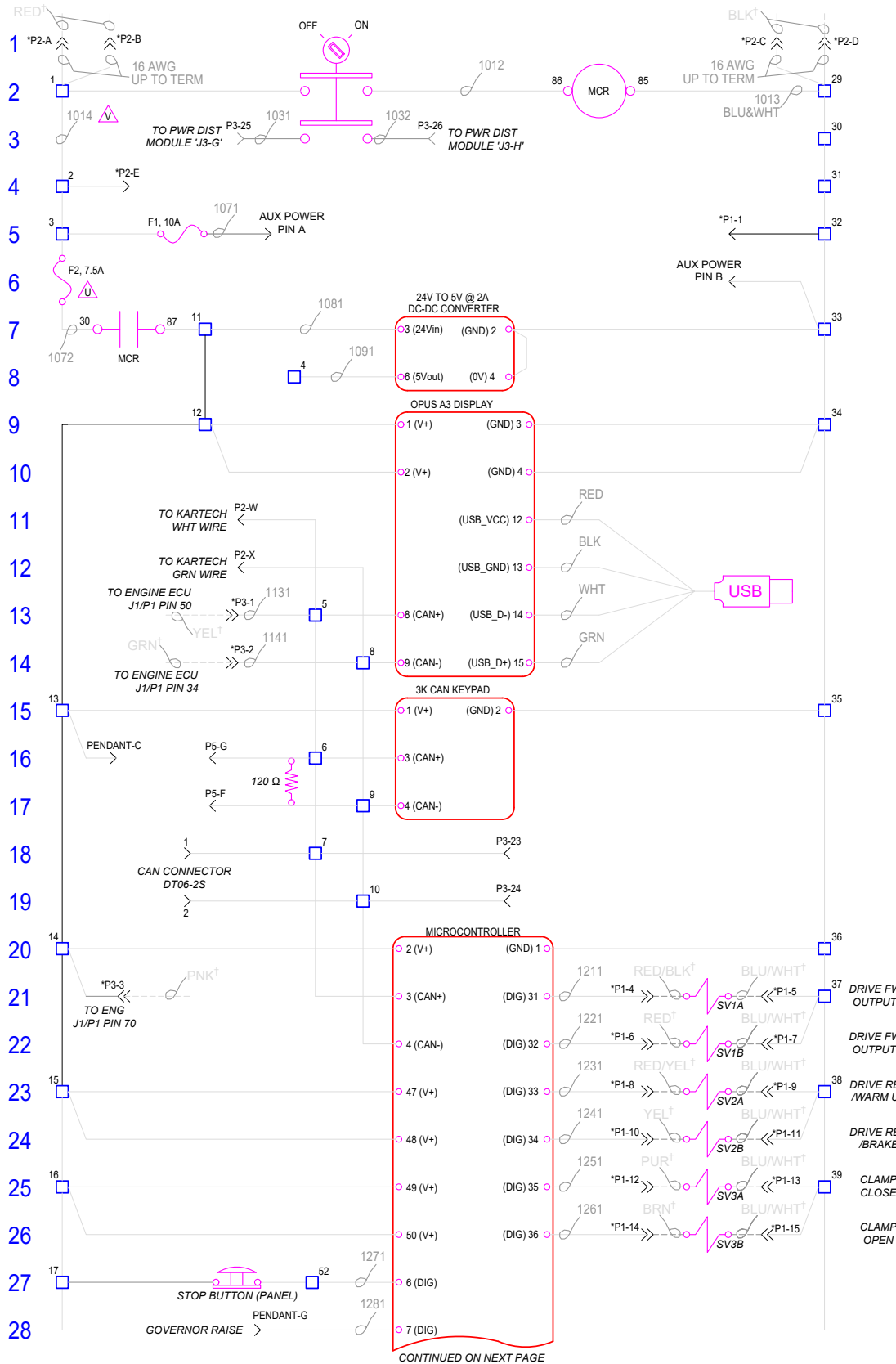

CONTINUED ON NEXT PAGE

TROUBLE SHOOTING



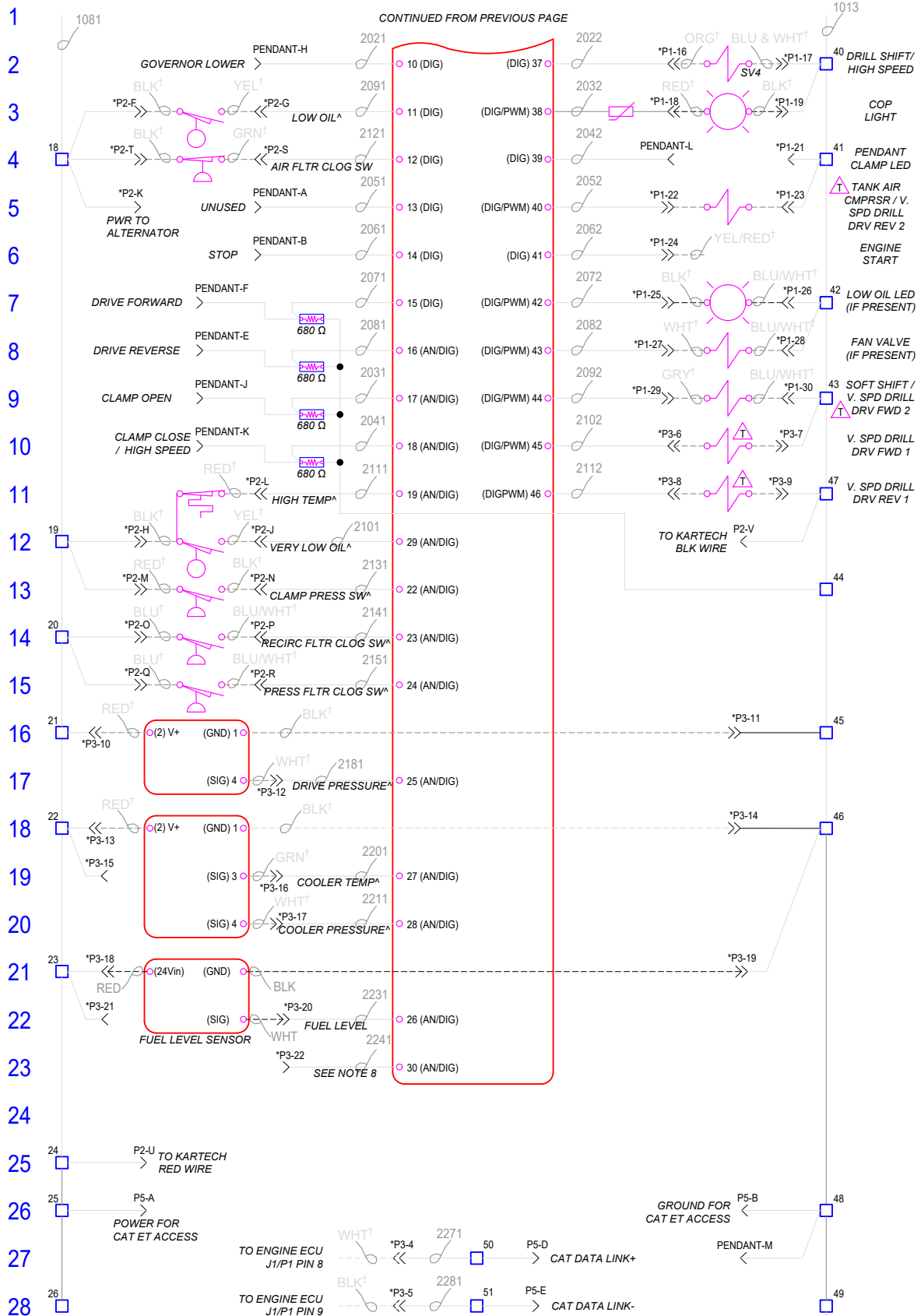

Power Distribution Module Electrical Schematic

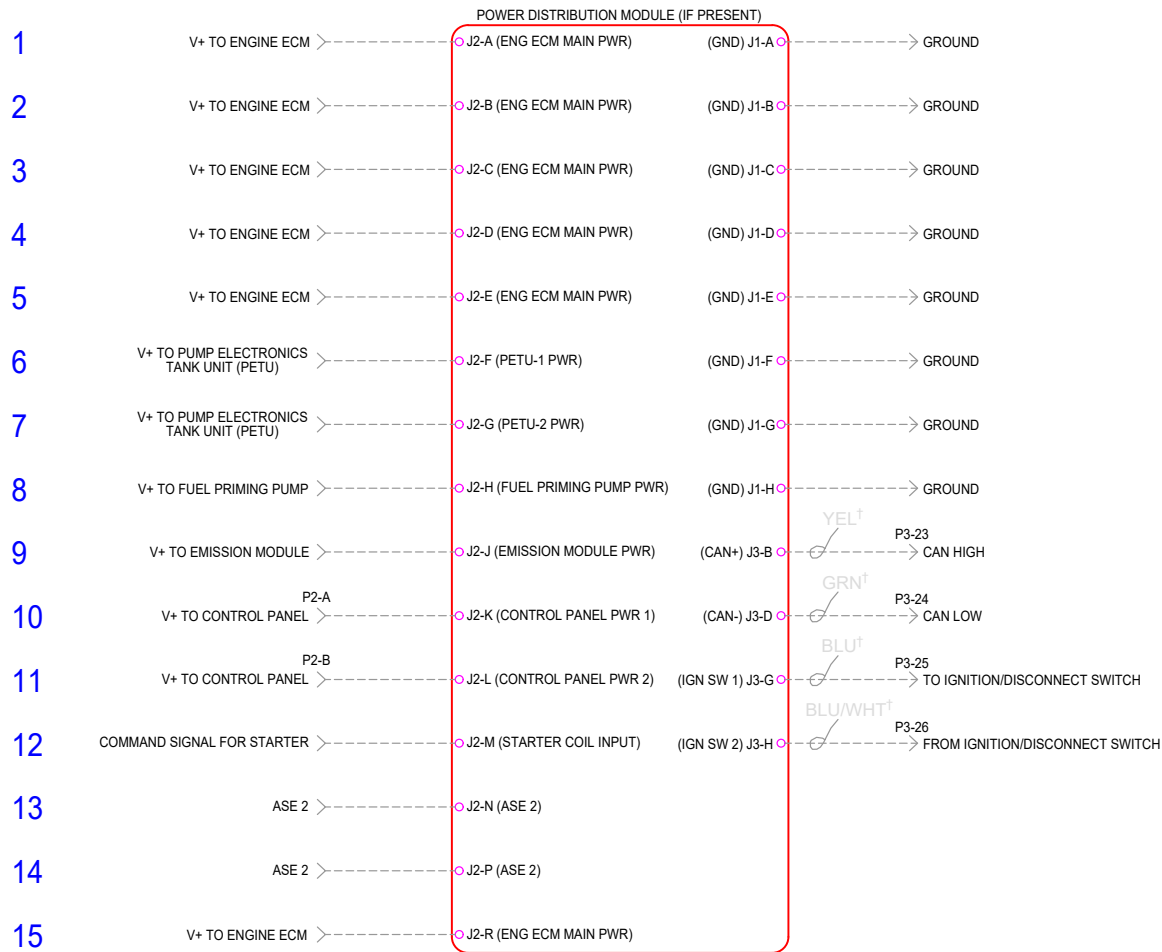

16 **NOTES:**

- 17 1) CONNECTIONS BETWEEN TERMINALS TO BE HARD JUMPERS UNLESS OTHERWISE INDICATED.
- 18 2) REFER TO LAYOUT DRAWING FOR LOCATIONS OF CONNECTORS 'P1', 'P2', 'P3', 'P4', 'AUX POWER', AND 'PENDANT'.
- 19 3) DASHED ELECTRICAL WIRE LINES INDICATE WIRING EXTERNAL TO THE ELECTRICAL BOX AND NOT PART OF THIS ASSEMBLY.
- 20 4) ALL WIRES TO BE BLUE 18 OR 20 AWG UNLESS OTHERWISE INDICATED.
- 21 5) ALL UNUSED POSITIONS IN BULKHEAD CONNECTORS TO BE PLUGGED WITH DEUTSCH SEALING PLUGS.
- 22 6) CONNECTOR P5 TO HANG LOOSE (WITH DUST CAP) INSIDE ENCLOSURE. USE CABLE ANCHOR TO SECURE CONNECTOR TO INNER SIDE OF ENCLOSURE. CONNECTOR PART NUMBER IS HD14-9-96P.
- 23 7) PINS WITH AN ASTERISK (*) ARE INCLUDED IN WIRE HARNESS TO EITHER A BULKHEAD CONNECTOR OR FLYING LEADS.
- 24 8) USE WITH DANFOSS SERVICE TOOL TO SELECT SENSORS FOR INPUTS 17, 18, 19, 22, 23, 24, 25, 27, 28, AND 30. INPUTS WITH (*) NOTED INDICATE WHAT IS TYPICAL.
- 25 9) WIRE COLORS WITH † NOTATION INDICATE WHAT IS TYPICAL FOR APE POWER UNIT WIRING AND MAY NOT BE EXACTLY AS NOTED ON ANY SPECIFIC POWER UNIT.
- 26 10) ROTARY, WINCH, AND SPARE CONTROLLED VIA DANFOSS PVG VALVE WITH PVE ELECTRONIC PILOT. WIRING FOR PVE VALVE POWER, GROUND, AND SIGNAL ON CONNECTOR POSITIONS 4, 3, AND 1, RESPECTIVELY.

22
23
24
25
26

TROUBLE SHOOTING



Setting up the Program

Prior to any program updates you will need:

1. A blank flash drive
2. A laptop with Plus + One Service guide software installed
<http://www2.powersolutions.danfoss.com/l/38972/2016-05-30/525qvt>
3. CAN to USB adapter P/N 1001190

To update the program you must first download and format the flash drive as follows:

1. Insert blank USB into your laptop.
 - a. Format USB by going to:
 - b. My computer
 - c. Right click on flash drive
 - d. Click on format and format as shown in the figure to the right.
2. Download all files from link provided
3. Extract all downloaded files onto USB drive.
4. All files in the folder labeled "**Display Program**" must be moved out of the folder or the update will not work.
5. On the bottom right of the screen eject USB to prevent any file corruption.

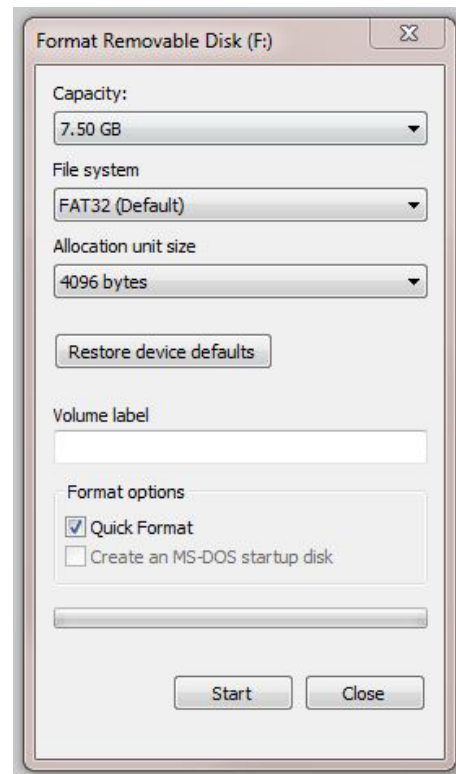

Updating the Display

To load the program onto the display from the USB drive follow steps below:

1. Make sure main power on the panel is turned off.
2. Open panel and plug-in USB drive into plug on the inside of the panel cover.
3. Hold down the top left two buttons on the display and turn on the main power. Continue to hold the two buttons down until the blue maintenance screen pops up on the display.
4. The display will auto update and count down from 15 and auto restart.
5. Wait 60 seconds then turn off main power and remove the USB drive.
6. Close the panel. Power-on to verify the update was successfully installed.

PRESS
HERE

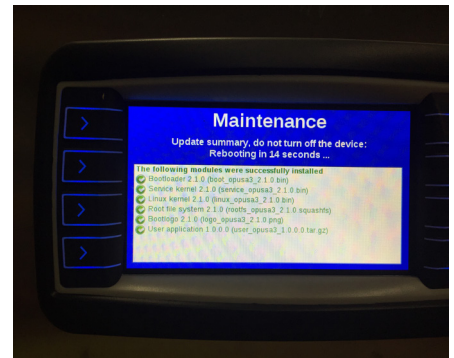
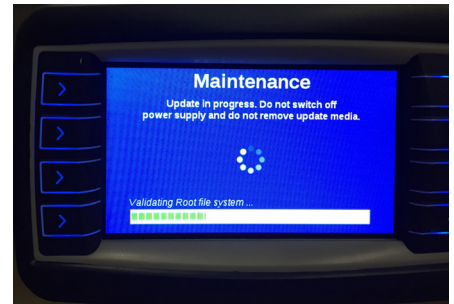

Updating the Panel

To update the power unit program follow the steps below:

1. Make sure main power on the panel is turned off.
 2. Open the panel.
 3. Plug in USB to CAN adapter to 2 wire CAN Plug on the inside of the panel.
 - Verify the CAN plug is wired properly. Wire #1131 is CAN high and should be in spot #1 in the plug. Wire #1141 is CAN low and should be in spot #2 in the plug.
 4. Turn on main panel power and verify the PWR and CAN lights are both lit on the Danfoss adapter.
 - If no connection is recognized verify, that the Plus-One service tool is online by going to communications and selecting online mode.
 - If online mode is on, verify you have the proper adapter model recognized by going to communications, gateway, and CG150-2.
 5. Locate the file on the USB drive under the folder labeled Micro-controller Program and open the folder.
 6. Double click on the file .
 7. Follow the prompts and start the download.
-
8. Once download is complete close the Plus + One service tool.
 9. Wait 60 seconds. Turn main panel power off and disconnect the USB to CAN adapter.
 10. Power-on the main panel power and verify program is successfully installed.

Danfoss adapter P/N: 1001190

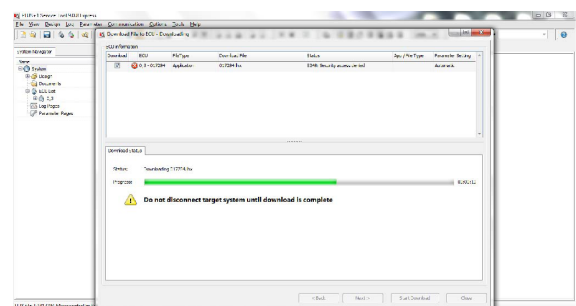
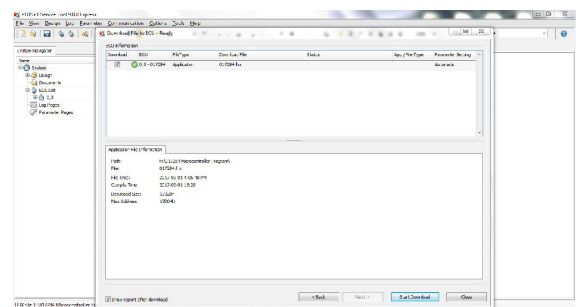
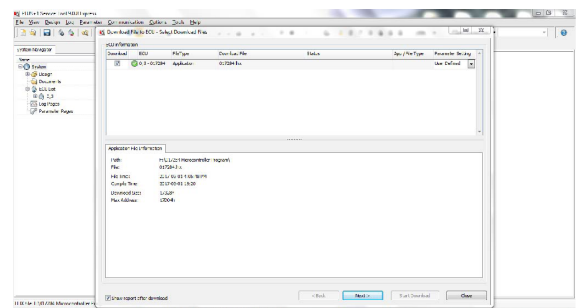
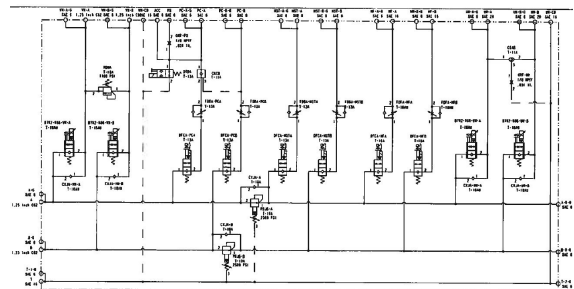

REPLACEMENT PARTS

Common Replacement Parts

LOCATION	ENGINE	PART NUMBER	APE PART NUMBER	QUANTITY
Engine Oil Filter Element	C18	1R-1808	521033	1
Fuel Filter/Water Separator	C18	326-1643	555131	1
Engine Fuel Filter	C18	1R-0749	521026	2
Inner Air Filter Element	C18	6I-2510	555137	2
Outer Air Filter Element	C18	6I-2509	521025B	2
Bypass Filter Element	C18	KKZ10	1001514	1
Return Filter Element	C18	KKZ25	100586	1
Handpump Fill Filter Element	C18	AE-25	521041	1

LOCATION	ENGINE	OIL TYPE	APE PART NUMBER	CAPACITY
Engine Oil	C18	Caterpillar DELO 15W-40	513001-15W40-D400-1	42 qt (40L)
Engine Coolant	C18	Caterpillar DEAC Antifreeze	513001-ANTI-A DEAC-1	Contact APE Service
Fuel	C18	Diesel Fuel	100725B	281 gal (1,064L)
Hydraulic Oil	C18	Envirologic 146	513001	510 gal (1,930L)
Pump Drive	C18	Schaeffer 268 SAE 140	513001S-SCH268	6 qt (5.7L)

DESCRIPTION	PART NUMBER	APE PART NUMBER	QUANTITY
Fuel Level Sensor	W392675	1006733	1
Hydraulic Level Sensor	B4004AFD2C758/6	1006759	2
Drive Pressure Transducer	3202H60CPS1P8R00	1005409	1
Cooler Bypass Transducer	3202H500PG1P8R00	1005295	1
Schroeder Indicator Sending Unit	MS19SSNC-75	1006992	1

DESCRIPTION	ENGINE	PART NUMBER	APE PART NUMBER
Battery	C18	GROUP SIZE 4D	541009
Fan Belt	C18	9L-6649	Contact APE Service
Alternator Belt	C18	4L-4648	Contact APE Service
Hydraulic Sight Gauge 30"	C18	L/D G607-30-A-1-4 30"	513005
Hydraulic Sight Gauge 6"	C18	G607-06-A-1-4-513003	513003
Fuel Level Gauge	C18	8680-01028	513050
HPS Control Panel	C18	018898	1006425
Solid State Power Distribution Module	C18	38032-1	1007224
Air Vacuum Switch W/ Deutsch Plug	C18	PS81-10-2MNB-C-FLS12-DE	531011
Hydraulic Tank Breather / Donaldson	C18	P563372	Contact APE Service
Hydraulic Tank Breather / Hydac	C18	BFP30U3W1.0/RV0.4	1003556



Double KL3 Bypass Manifold Assembly

P/N: 1006781

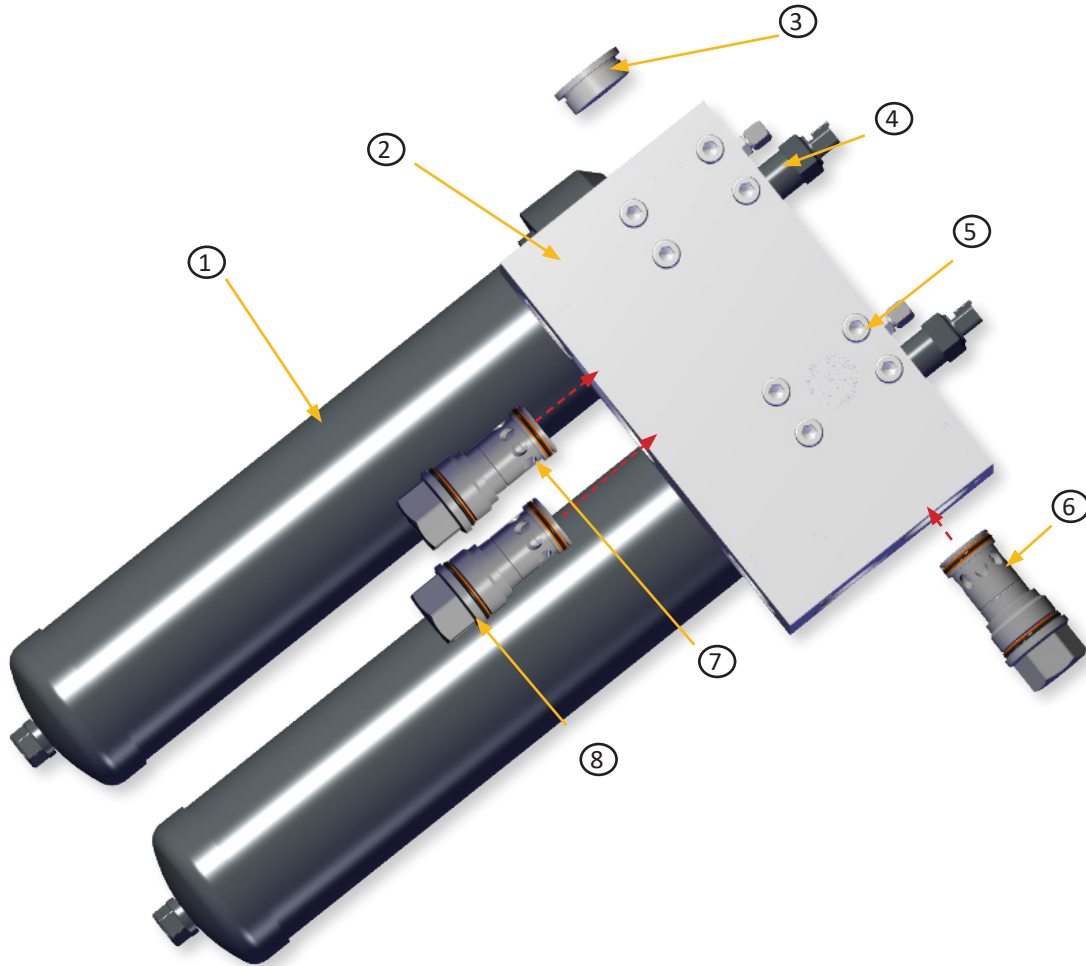

CALLOUT	PART #	APE PART NUMBER	DESCRIPTION
1	KL31KKZ10F2450MS19NCLDRG2171	1008468	Return Filter
2	HPS-019393	CONTACT FACTORY	KL3 3-Check Cooler Bypass Manifold Body
3	6408-HHP-24	110298	-24 M-ORB O-Ring Hollow Hex Plug
4	3202H500CPS1P8R00	1005295	500 PSI Temp / Pressure Transducer
5	1/2-13X5-SHCS-ZINC	CONTACT FACTORY	Socket Head Cap Screw
6	CXKAXBN	1000826	15 PSI Check Valve
7	CXKAXGN	1000825	150 PSI Check Valve
8	CXKAXFN	1000674	100 PSI Check Valve

REPLACEMENT PARTS

32mm Drive Manifold Assembly

P/N: 1006850

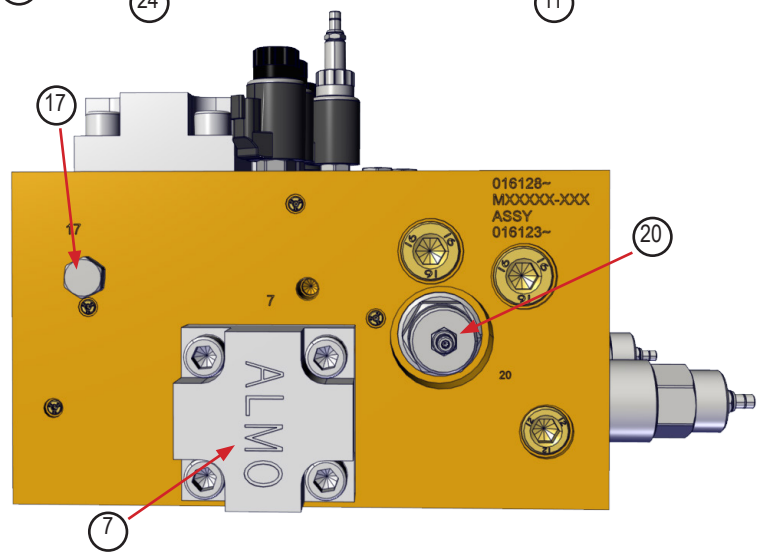
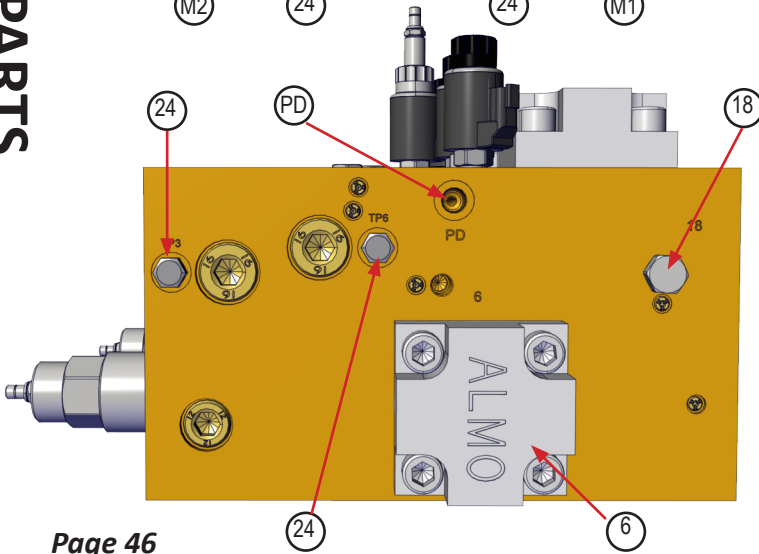
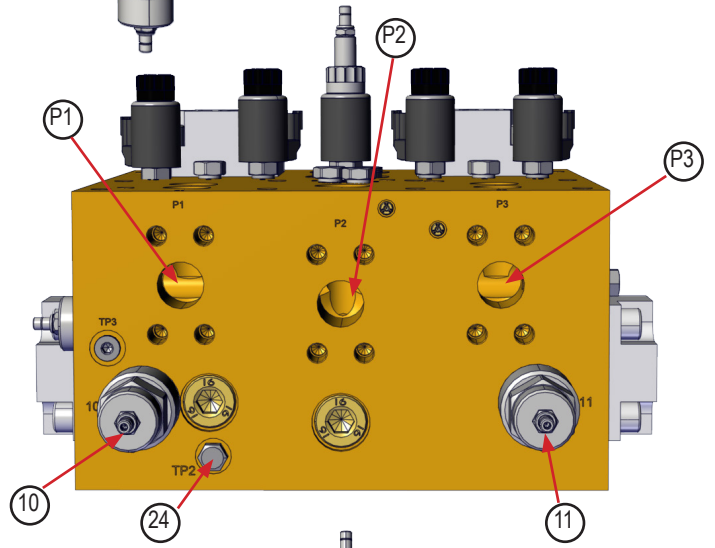
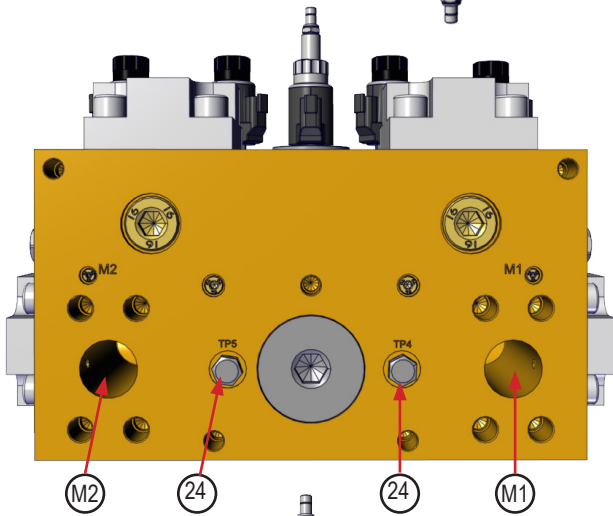
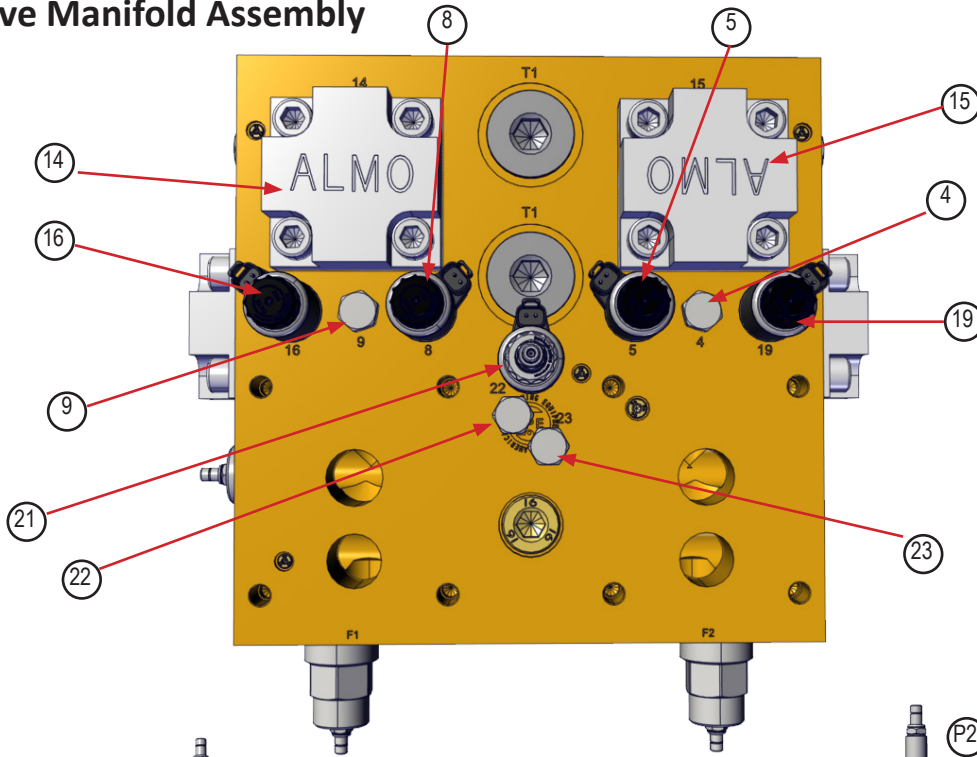

REPLACEMENT PARTS

REPLACEMENT PARTS

CALLOUT	PART #	APE PART NUMBER	DESCRIPTION	QTY
1	016128	CONTACT APE	DUCTILE IRON MANIFOLD BODY	1
1A	-		PAINT BLACK EPOXY	1
4	FXAA-XDN	2000001	PRESS COMP FLOW CONTROL FIXED	1
5	DAAL-MHN	CONTACT APE	DIRECTIONAL VALVE, 2P2W N.O.	1
5A	770924	1005159	COIL ; 24VDC ; DEUTSCH	1
6	AMT-LCV-32-1.6-D-30	CONTACT APE	LOGIC CARTRIDGE W/ THROTTLE	1
6A	AMT-PCC-32-C-BL	CONTACT APE	THROTTLE CARTRIDGE W/ BOLTS	1
7	AMT-LCV-32-1.6-D-30	CONTACT APE	LOGIC CARTRIDGE W/ THROTTLE	1
7A	AMT-LCV-32-C-BL	CONTACT APE	THROTTLE CARTRIDGE W/ BOLTS	1
8	DAAL-MHN	CONTACT APE	2-WAY DIRECTIONAL SPOOL VALVE	1
8A	770924	1005159	COIL ; 24VDC ; DEUTSCH	1
9	FXAA-XDN	2000001	PRESS COMP FLOW CONTROL FIXED	1
11	RDJA-LWN	631065	RELIEF VALVE, DIRECT ACTING, T-18A	1
11	RDJA-LWN	631065	RELIEF VALVE, DIRECT ACTING	1
14	AMT-LCV-32-1.6-D-30	CONTACT APE	LOGIC CARTRIDGE W/ THROTTLE	1
14A	AMT-PCC-32-C-BL	CONTACT APE	THROTTLE CARTRIDGE W/ BOLTS	1
15	AMT-LCV-32-1.6-D-30	CONTACT APE	LOGIC CARTRIDGE W/ THROTTLE	1
15A	AMT-LCV-32-C-BL	CONTACT APE	THROTTLE CARTRIDGE W/ BOLTS	1
16	DAAL-MHN	CONTACT APE	2-WAY DIRECTIONAL SPOOL VALVE	1
16A	770924	1005159	COIL ; 24VDC ; DEUTSCH	1
17	FXAA-XDN	2000001	PRESS COMP FLOW CONTROL FIXED	1
18	FXAA-XDN	2000001	PRESS COMP FLOW CONTROL FIXED	1
19	DAAL-MHN	CONTACT APE	2-WAY DIRECTIONAL SPOOL VALVE	1
19A	770924	1005159	COIL ; 24VDC ; DEUTSCH	1
20	RPKC-LWN	2000004	RELIEF VALVE, PO, BALANCED PISTON	1
21	RBAP-LWN	1008508	PROPORTIONAL RELIEF VALVE	1
21A	770924	1005159	COIL ; 24VDC ; DEUTSCH	5
23	CXAA-XBN	2000005	CHECK VALVE	1
23	CXAA-XBN	2000005	CHECK VALVE	1
24	6408-06	600123	PORT PLUGS	5

If Pressure Filters Are Installed

-	KC651KKZX10090G3241	1009111	PRESSURE FILTER MOUNT W/ STEEL PLUG	2
-	MS19SSNC-75	1006992	6K PRESSURE FILTER ELECTRONIC INDICATOR	1
-	27KZ10	1001515	PRESSURE FILTER REPLACEMENT ELEMENT	



REPLACEMENT PARTS

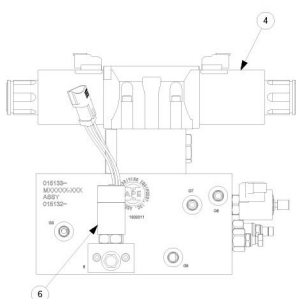
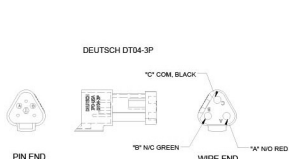
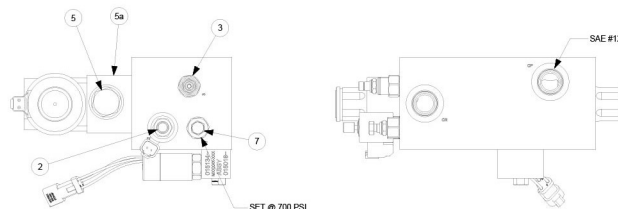
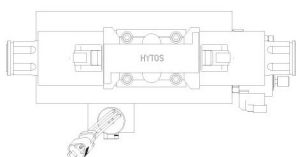
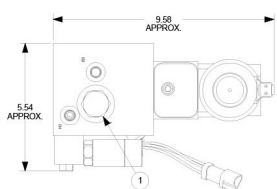

REPLACEMENT PARTS

CALLOUT	PART #	APE PART NUMBER	DESCRIPTION	QTY
0		015133	Ductile Manifold Body	1
1	FRDA-XAN	555019	Priority Flow Control	1
2	SV08-40M-0-N-00	513119	Solenoid Valve	1
2a	4301524	1004749	Coil, 24V DC Deutsch	1
3	RPEC-LWN	1001658	Relief Valve, PO, Balanced Piston	1
4	RPE4-103H11 / 02400E11B	1004886	Directional Valve	1
4a			SHCS 1/4-20 x 3.5	1
5	CKEB-XCN	222016	P.O. Check Valve T-2a	1
5a	BBA/S		Sandwich Body (D05)	1
6	015018	1001914	Pressure Switch Assembly	1
7	RDDA-LBN	1001344	Relief Valve	1
8	HPS 1/16 NPT-FL/ PLG-7/8 TOR-SOFT		Orifice Plug $\varnothing 0.031$	1
9			Not Used	0
10	HPS 1/16 NPT-FL/ PLG-7/8 TPR-SOFT		1/16 NPT Plug	1

Cooler Package Arrangement

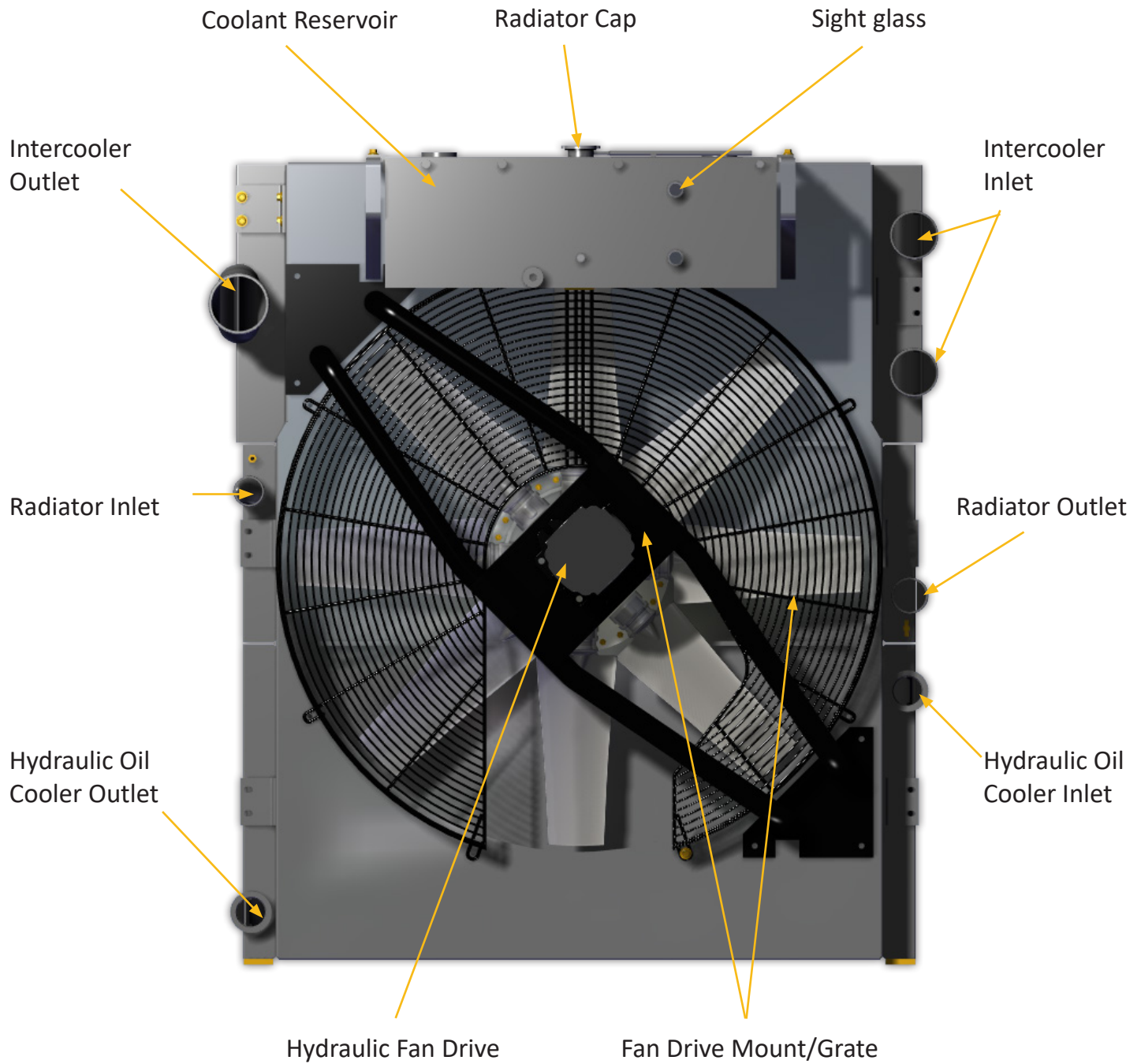

REPLACEMENT PARTS



UNDERSTANDING ISO CODES

The ISO cleanliness code is used to quantify particulate contamination levels per milliliter of fluid at 3 sizes 4µ[c], 6µ[c], and 14µ[c]. The ISO code is expressed in 3 numbers (ie 19/17/14). Each number represents a contaminant level code for the correlating particle size. The code includes all particles of the specified size and larger. It is important to note that each time a code increases the quantity range of particles is doubling.

ISO 4406 Chart		
Range Code	Particles per milliliter	
	More than	Up to/including
24	80000	160000
23	40000	80000
22	20000	40000
21	10000	20000
20	5000	10000
19	2500	5000
18	1300	2500
17	640	1300
16	320	640
15	160	320
14	80	160
13	40	80
12	20	40
11	10	20
10	5	10
9	2.5	5
8	1.3	2.5
7	0.64	1.3
6	0.32	0.64

Sample 1 (see photo 1)

Particle Size	Particles per ml*	ISO 4406 Code range	ISO Code
4µ[c]	151773	80000~160000	24
6µ[c]	38363	20000~40000	22
10µ[c]	8229		
14µ[c]	3339	2500~5000	19
21µ[c]	1048		
38µ[c]	112		

Sample 2 (see photo 2)

Particle Size	Particles per ml*	ISO 4406 Code range	ISO Code
4µ[c]	492	320 ~ 640	16
6µ[c]	149	80 ~ 160	14
10µ[c]	41		
14µ[c]	15	10 ~ 20	11
21µ[c]	5		
38µ[c]	1		

Photo 1

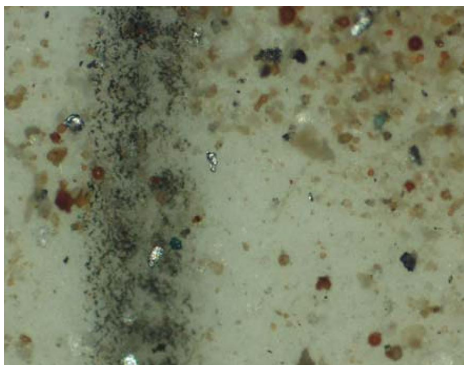

Photo 2



TARGET ISO CLEANLINESS CODES

When setting target ISO fluid cleanliness codes for hydraulic and lubrication systems it is important keep in mind the objectives to be achieved. Maximizing equipment reliability and safety, minimizing repair and replacement costs, extending useful fluid life, satisfying warranty requirements, and minimizing production down-time are attainable goals. Once a target ISO cleanliness code is set following a progression of steps to achieve that target, monitor it, and maintain it justifiable rewards will be yours.

Set the Target.

The first step in identifying a target ISO code for a system is to identify the most sensitive on an individual system, or the most sensitive component supplied by a central reservoir. If a central reservoir supplies several systems the overall cleanliness must be maintained, or the most sensitive component must be protected by filtration that cleans the fluid to the target before reaching that component.

Other Considerations

Table 1 recommends conservative target ISO cleanliness codes based on a several component manufacturers guidelines and extensive field studies for standard industrial operating conditions in systems using petroleum based fluids. If a non-petroleum based fluid is used (i.e. water glycol) the target ISO code should be set one value lower for each size (4 μ[c]/6μ[c]/14μ[c]). If a combination of the following conditions exists in the system the target ISO code should also be set one value lower:

- Component is critical to safety or overall system reliability.
- Frequent cold start.
- Excessive shock or vibration.
- Other Severe operation conditions.

Recommended* Target ISO Cleanliness Codes and media selection for systems using petroleum based fluids per ISO4406:1999 for particle sizes 4μ[c] / 6μ[c] / 14μ[c]

	Pressure < 140 bar < 2000 psi	Media βx[c] = 1000 (βx = 200)	Pressure 212 bar 3000 psi	Media βx[c] = 1000 (βx = 200)	Pressure > 212 bar > 3000 psi	Media βx[c] = 1000 (βx = 200)
Pumps						
Fixed Gear	20/18/15	22μ[c] (25 μ)	19/17/15	12μ[c] (12 μ)	-	-
Fixed Piston	19/17/14	12μ[c] (12 μ)	18/16/13	12μ[c] (12 μ)	17/15/12	7μ[c] (6 μ)
Fixed Vane	20/18/15	22μ[c] (25 μ)	19/17/14	12μ[c] (12 μ)	18/16/13	12μ[c] (12 μ)
Variable Piston	18/16/13	7μ[c] (6 μ)	17/15/13	5μ[c] (3 μ)	16/14/12	7μ[c] (6 μ)
Variable Vane	18/16/13	7μ[c] (6 μ)	17/15/12	5μ[c] (3 μ)	-	-
Valves						
Cartridge	18/16/13	12μ[c] (12 μ)	17/15/12	7μ[c] (6 μ)	17/15/12	7μ[c] (6 μ)
Check Valve	20/18/15	22μ[c] (25 μ)	20/18/15	22μ[c] (25 μ)	19/17/14	12μ[c] (12 μ)
Directional (solenoid)	20/18/15	22μ[c] (25 μ)	19/17/14	12μ[c] (12 μ)	18/16/13	12μ[c] (12 μ)
Flow Control	19/17/14	12μ[c] (12 μ)	18/16/13	12μ[c] (12 μ)	18/16/13	12μ[c] (12 μ)
Pressure Control (modulating)	19/17/14	12μ[c] (12 μ)	18/16/13	12μ[c] (12 μ)	17/15/12	7μ[c] (6 μ)
Proportional Cartridge Valve	17/15/12	7μ[c] (6 μ)	17/15/12	7μ[c] (6 μ)	16/14/11	5μ[c] (3 μ)
Proportional Directional	17/15/12	7μ[c] (6 μ)	17/15/12	7μ[c] (6 μ)	16/14/11	5μ[c] (3 μ)
Proportional Flow Control	17/15/12	7μ[c] (6 μ)	17/15/12	7μ[c] (6 μ)	16/14/11	5μ[c] (3 μ)
Proportional Pressure Control	17/15/12	7μ[c] (6 μ)	17/15/12	7μ[c] (6 μ)	16/14/11	5μ[c] (3 μ)
Servo Valve	16/14/11	7μ[c] (6 μ)	16/14/11	5μ[c] (3 μ)	15/13/10	5μ[c] (3 μ)
Bearings						
Ball Bearing	15/13/10	5μ[c] (3 μ)	-	-	-	-
Gearbox (industrial)	17/16/13	12μ[c] (12 μ)	-	-	-	-
Journal Bearing (high speed)	17/15/12	7μ[c] (6 μ)	-	-	-	-
Journal Bearing (low speed)	17/15/12	7μ[c] (6 μ)	-	-	-	-
Roller Bearing	16/14/11	7μ[c] (6 μ)	-	-	-	-
Actuators						
Cylinders	17/15/12	7μ[c] (6 μ)	16/14/11	5μ[c] (3 μ)	15/13/10	5μ[c] (3 μ)
Vane Motors	20/18/15	22μ[c] (25 μ)	19/17/14	12μ[c] (12 μ)	18/16/13	12μ[c] (12 μ)
Axial Piston Motors	19/17/14	12μ[c] (12 μ)	18/16/13	12μ[c] (12 μ)	17/15/12	7μ[c] (6 μ)
Gear Motors	20/18/14	22μ[c] (25 μ)	19/17/13	12μ[c] (12 μ)	18/16/13	12μ[c] (12 μ)
Radial Piston Motors	20/18/15	22μ[c] (25 μ)	19/17/14	12μ[c] (12 μ)	18/16/13	12μ[c] (12 μ)
Test Stands, Hydrostatic						
Test Stands	15/13/10	5μ[c] (3 μ)	15/13/10	5μ[c] (3 μ)	15/13/10	5μ[c] (3 μ)
Hydrostatic Transmissions	17/15/13	7μ[c] (6 μ)	16/14/11	5μ[c] (3 μ)	16/14/11	5μ[c] (3 μ)

*Depending upon system volume and severity of operating conditions a combination of filters with varying degrees of filtration efficiency might be required (i.e. pressure, return, and off-line filters) to achieve and maintain the desired fluid cleanliness.

Example	ISO Code	Comments
Operating Pressure	156 bar, 2200 psi	
Most Sensitive Component	Directional Solenoid	19/17/14 recommended baseline ISO Code
Fluid Type	Water Glycol	18/16/13 Adjust down one class
Operating Conditions	Remote location, repair difficult High ingress rate	17/15/12 Adjust down one class, combination of critical nature, severe conditions

RECOMMENDED BOLT TIGHTENING TORQUE “LUBRICATED SHCS”

Socket Head Cap Screws

When installing any APE equipment or parts apply lubricant and use APE standard **Anti-Seize** torque specs. See Tightening Torque Spec below. Failure to follow tightening torque spec can result in under / over tightening fasteners, leading to equipment failure or personal injury.



COARSE THREADS

Nominal Screw Size	Nominal Socket Size	Tightening Torque (ft-lbs)
#10-24	5/32	6
.25-20	3/16	10
.31-18	1/4	22
.38-16	5/16	38
.44-14	3/8	61
.50-13	3/8	93
.63-11	1/2	179
.75-10	5/8	317
.88-9	3/4	511
1.00-8	3/4	767
1.25-7	7/8	1,533
1.50-6	1	2,668

FINE THREADS

Nominal Screw Size	Nominal Socket Size	Tightening Torque (ft-lbs)
#10-32	5/32	6
.25-28	3/16	12
.31-24	1/4	24
.38-24	5/16	43
.44-20	3/8	68
.50-20	3/8	105
.63-18	1/2	202
.75-16	5/8	354
.88-14	3/4	564
1.00-12	3/4	860
1.25-12	7/8	1,697
1.50-12	1	3,001

RECOMMENDED ANTI-SEIZE LUBRICANT

BENEFITS & FEATURES

- **Excellent Anti-Seize** Prevents seizing caused by galling, galvanic action, fretting, fusion, pitting, thread distortion, breakage, rust, and corrosion.
- **Water Resistant** Provides long term protection with just one application, outdoors or indoors, even in the damp areas or against salt spray. Will not wash off.
- **Wide Temperature Range** Coating withstands temperatures of -65 Degree F to 2100 Degree F. (-54 C to 1100 C)
- **Stable Coating** Will not harden or fuse to metal, cake, evaporate or separate
- **Compatible with many materials** Can be used as an anti-seize on the threads of steel, stainless steel, steel alloy, cast iron, aluminum, copper brass, and titanium parts and reduces friction and wear on plastic.
- **Environmentally Desirable** Past contains no lead compounds traditionally found in this type of product.



WARNING: USING OTHER TYPES OF ANTI-SEIZE NOT RECOMMENDED BY APE CAN LEAD TO EQUIPMENT FAILURE OR PERSONAL INJURY. WARRANTY WILL BE VOIDED AND FEES MAY APPLY.

REFERENCE / NOTES

All information given in this Manual is current and valid per the information available at the time of publication. (Please check the updated revision date at the bottom of each page.)

American Piledriving Equipment (APE) reserves the right to implement changes without prior notice.

Please visit www.americanpiledriving.com for the most recent version of this publication.

AMERICAN PILEDRIVING EQUIPMENT, INC.
7032 S. 196th Street
Kent, Washington 98032
Office: 253-872-0141
Toll Free: 800-248-8498
Fax: 253-872-8710



800-248-8498
WWW.AMERICANPILEDRIVING.COM

MODEL 800 POWER UNIT

Copyright © 2020 American Piledriving Equipment Inc. All Rights Reserved